

Public Address Audio System——Mini Mixer Amplifier



Model No.: USB-1050B
Power: 50W
Voltage: 110V
Function: USB Bluetooth
Product Size: 260x210x70mm



Model No.: QG-2060AT
Power: 60W
Voltage: 110V
Function: USB Bluetooth 2 zones independent control
Product Size: 285x285x70mm



Model No.: MP3-80
Power: 80W
Voltage: 110V
Function: USB Bluetooth 3 zones
Product Size: 260x210x70mm



Model No.: USB-50AL
Power: 50W
Voltage: 110V
Function: USB Bluetooth
Product Size: 260x200x70mm



Model No.: USB-40C
Power: 40W
Voltage: 110V
Function: USB Bluetooth
Product Size: 220x170x70mm



Model No.: USB-8080
Power: 80W
Voltage: 110V
Function: USB Bluetooth
Product Size: 300x200x65mm



Model No.: USB-50
Power: 50W
Voltage: 110V
Function: USB Bluetooth
Product Size: 260x200x70mm



Model No.: USB-60C
Power: 60W
Voltage: 110V
Function: USB Bluetooth
Product Size: 240x210x70mm



Model No.: USB-2070B
Power: 70W
Voltage: 110V
Function: USB Bluetooth 2 zones
Product Size: 320x205x65mm



Public Address Audio System——Mixer power amplifier



USB-120 / USB-180
(120W) (180W)



Chassis: 1.5U
Partition function: 2 zones individual control
Voltage: 110V
Function: USB Bluetooth
Product Size: 480x265x66mm



USB-MP60 / USB-MP120 / USB-MP180
(60W) (120W) (180W)



Chassis: 1.5U
Partition function: 2 zones individual control
Voltage: 110V
Function: USB Bluetooth
Product Size: 480x265x66mm



MP3-4x100U

With Echo



MP3-4x100U



4CH 4*100W Constant resistance power amplifier



MP3-4x150U



MP3-4x150U



4CH 4*150W Constant resistance power amplifier



ET-8050



ET-8050



Constant voltage & Constant resistance integrated power amplifier



USB-MP4060 / USB-MP4120 / USB-MP4150
(60W) (120W) (180W)

Model No.: USB-MP4060 (60W)
USB-MP4120 (120W)
USB-MP4150 (150W)

Chassis: 1.5U
Partition function: 4 zones
Voltage: 110V
Function: USB
Product Size: 480x265x66mm



MA-80 / MA-120 / MA-180
(80W) (120W) (180W)



Chassis: 1.5U
Partition function: 2 zones individual control
Voltage: 110V
Function: USB Bluetooth
Product Size: 480x265x66mm

Model No.	Rated Power	Size
MP3-4x100U	Constant resistance 4*100W	500*300*120mm
MP3-4x150U	Constant resistance 4*150W	500*300*120mm
ET-8050	Constant voltage 80W/ Constant resistance 4*50W	500*300*120mm

ET8050 functional description

- With preamp, 2CH microphone input, and M1C1 microphone is with Emergency broadcast function, Tremble+Bass Adjustment;
- 3CH signal line input, 2CH signal line output, CD/audio source/telephone are available, Microphone & Signal Line & media Volume Control on each channel;
- Short circuit, overload, overheating, and other protection;
- Power 80W is the most ideal power amplifier for multimedia classrooms, KTV audio, 4CH output, each channel 4-16Ω;
- Radio function, Bluetooth function, Volume Control on each channel;
- Best for the supermarket chain (indoor: connect 4-8 coaxial speakers, improve the sound quality, outdoor: install 2*40W speakers);

MP3-4x150U functional description

- With preamp, 4CH microphone input, and M1C1 microphone is with Emergency broadcast function, Tremble+Bass Adjustment;
- 3CH signal line input, 2CH signal line output, CD/audio source/telephone are available, Microphone & Signal Line & media Volume Control on each channel;
- Short circuit, overload, overheating, and other protection;
- Power 4x150W is the most ideal power amplifier for multimedia classrooms, KTV audio, 4CH output, each channel 4-16Ω is available to connect 2 pieces Constant resistance speakers at same time;
- Big display with USB, Radio function, Bluetooth function, 2-CH zone, 2 output switch on each zone;

Public Address Audio System—Power Amplifier with USB & 6-zones & Bluetooth



Aluminum silver sandblasted panel



US8-MP6120 / USB-MP6180 / USB-MP6250 / USB-MP6350 / USB-MP6500 / USB-MP6650 / USB-MP6800 / USB-MP6100 / USB-MP61500 / USB-MPR62000

Description

- ◆ With preamp, 2CH microphone input, and M1C1 microphone is with Emergency broadcast function, Tremble+Bass Adjustment;
- ◆ 3CH signal line input, 2CH signal line output, CD/audio source/telephone are available;
- ◆ Short circuit, overload, overheating, and other protection;
- ◆ 6-zones output, USB digital display, radio function, USB and SD card;
- ◆ With Bluetooth, remote control function, electronic touch partition control mode, partition control for relay suction mode;
- ◆ 6-zones knob light switch to show the working status;

Rated Power	120W/180W/250W/350W/500W/650W	800W/1000W/1500W/2000W
Input	100V/120V; 220VAC/50Hz	
Frequency Range	60Hz~16KHz \pm 2dB	
Output	6-channel partition (with LCD/radio)	
THD	0.1% (1KHz 0dB)	
SNR	Microphone: 66dB; Line: 102dB	
Input/S.P.L	Microphone: -50dB/600 Ω ; Line: -10dB/10K Ω	
Size (mm)	Product Size: 480 \times 370 \times 88 Package Size: 570 \times 540 \times 170	Product Size: 635 \times 570 \times 197 Package Size: 650 \times 585 \times 215

Public Address Audio System—— 6 Zones Power Amplifier



Description

- ◆ 2-CH Microphone & 3-CH Line input, 6-zones of independent control, each way can be loaded independently, 75% of the total power, the volume of each way can be independently controlled;
- ◆ 6-zones of independent volume control, all the way through;
- ◆ Priority (silent) function, easy to have emergency broadcast function;
- ◆ High and low adjustment $\pm 20\text{dB}$;
- ◆ With monitoring output, can also expand another power amplifier
- ◆ 6 LED level indicators;
- ◆ Multiple protection functions: short circuit, overload, delay;
- ◆ 6-partition output, each partition can be independently switched/sized music, USB digital display, with radio function, USB and SD card, Bluetooth, remote control, digital display function;

Model No.	QG-6120AT/QG-6180AT/QG-6250AT/QG-6350AT/QG-6500AT/QG-6650AT
Rated Power	120W/180W/250W/350W/500W/650W
Input	100V/120V; 220VAC/50Hz
Frequency Range	60Hz~16KHz $\leq \pm 2\text{dB}$
Output	6-channel partition volume output independently
THD	0.1% (1KHz 0dB)
SNR	Microphone: 66dB; Line: 102dB
Input/S.P.L	Microphone: -50dB/600 Ω ; Line: -10dB/10K Ω
Size (mm)	Product Size: 480×370×88 Package Size: 570×540×170

Public Address Audio System—USB&Zone independent control



- ★ USB/FM/Bluetooth
- ★ 4-CH/6-CH/8-CH/Zone independent control



Model No.	QG-7120AT	QG-7180AT	QG-7250AT	QG-7350AT	QG-7500AT	QG-7500AT	QG-7800AT	QG-71000AT	QG-71500AT	QG-72000AT
Rated Power	120W	180W	250W	350W	500W	650W	800W	1000W	1500W	2000W
Input	100V/120V; 220VAC/50Hz									
Frequency Range	60Hz~16KHz \pm 2dB									
Output	4-channel partition volume output independently		6-channel partition volume output independently				8-channel partition volume output independently			
THD	0.1% (1KHz 0dB)									
SNR	Microphone: 66dB; Line: 102dB									
Input/S.P.L	Microphone: -50dB/600 Ω ; Line: -10dB/10K Ω									
Size (mm)	Product Size: 480×370×88 Package Size: 570×540×170						Product Size: 485×530×154 Package Size: 570×540×170			

Public Address Audio System——Power Amplifier with USB

USB-4 series 4-zones Constant voltage amplifier



Features:

- ★All-digital circuit amplifier
- ★High Power
- ★Light Weight
- ★Bigger Load, Louder Sound
- ★Stability circuit design
- ★All-digital Constant voltage
- ★4-CH/6-CH zones
- ★Bluetooth&USB

Model No.	USB-4180B	USB-4250B	USB-4350B	USB-4500B	USB-4600B	USB-4800B
Rated Power	180W	250W	350W	500W	600W	800W
Input	100V/120V; 220VAC/50Hz					
Frequency Range	60Hz~16KHz \pm 2dB					
Partition Output	4-channel partition independent control					6-channel partition
Output	Support 8~16Q/70V100V/4-CH 100V partition output					
THD	0.1% (1KHz 0dB)					
SNR	Microphone: <0108dB EIN; Line: > 88dB					
Input/S.P.L	Microphone: -50dB 600ohms unbalanced; Line: -10dB/10K Ω unbalanced					
Product Size (mm)	480×325×88					480×325×132
Package Size(mm)	565×415×370					545×390×180

Public Address Audio System——Combined constant voltage power amplifier

Support Bluetooth&USB&Zone&Line input function

★USB&FM&Bluetooth

★6-CH/8-CH zones independent control constant voltage power amplifier



Model No.	QG-9120AT	QG-9180AT	QG-9250AT	QG-9350AT	QG-9500AT	QG-9650AT	QG-9800AT	QG-91000AT	QG-91500AT	QG-92000AT
Rated Power	120W	180W	250W	350W	500W	650W	800W	1000W	1500W	2000W
Input	100V/120V; 220VAC/50Hz									
Frequency Range	60Hz~16KHz \leq \pm 2dB									
Output	6-zones independent control (LCD/FM/Bluetooth)						8-zones independent control (LCD/FM/Bluetooth)			
THD	0.1% (1KHz 0dB)									
SNR	Microphone: 66dB; Line: 102dB									
Input/S.P. L	Microphone: -50dB/600 Ω ; Line: -10dB/10K Ω									
Size (mm)	Product Size: 480 \times 370 \times 88 Package Size: 570 \times 540 \times 170						Product Size: 485 \times 530 \times 154 Package Size: 570 \times 540 \times 170			

- ◆ With Preamp, 3CH microphone input, and M1C1 microphone is with Emergency broadcast function, Tremble+Bass Adjustment at \pm 20dB;
- ◆ 3CH signal line input, 2CH signal line output, CD/audio source/telephone are available;
- ◆ Microphone & Signal Line & media Volume Control on each channel;
- ◆ Short circuit, overload, overheating, and other protections;
- ◆ 6-CH/8-CH Zones output, Music power switch for each channel zone, USB digital display, touch screen, remote control, bluetooth, FM, USB,SD card;
- ◆ Partition control for relay suction mode, 6-zones knob light switch to show the working status;
- ◆ 2CH microphone & 3CH signal line input, 6 Zones with independent control, each channel can load 75% of the total power, the volume of each way can be independently controlled;
- ◆ With monitoring output, it can also be extended to another power amplifier;
- ◆ 6 LED level indicators;

Public Address Audio System—USB/6-Zones/Bluetooth Constant voltage Amplifier



- ★USB&FM&Bluetooth
- ★6-Zones
- ★6-CH zones Volume independent control



Model No.	REC-6120	REC-6180	REC-6250	REC-6350	REC-6500	REC-6650	REC-6120AT	REC-6180AT	REC-6250AT	REC-6350AT	REC-6500AT	REC-6650AT
Rated Power	120W	180W	250W	350W	500W	650W	120W	180W	250W	350W	500W	650W
Input	100V/120V; 220VAC/50Hz											
Frequency Range	60Hz~16KHz \pm 2dB											
Output	6-zones (LCD/FM/Bluetooth)			6-CH zones			Bluetooth 60Hz~16KHz \pm 2dB					
THD	0.1% (1KHz 0dB)											
SNR	Microphone: 66dB; Line: 102dB											
Input/S.P.L	Microphone: -50dB/600 Ω ; Line: -10dB/10K Ω											
Size (mm)	Product Size: 480 \times 370 \times 88 Package Size: 570 \times 540 \times 170											

- ◆ With Preamp, 2CH microphone input, and M1C1 microphone is with Emergency broadcast function, Tremble+Bass Adjustment at \pm 20dB;
- ◆ 3CH signal line input, 2CH signal line output, CD/audio source/telephone are available;
- ◆ Microphone & Signal Line & media Volume Control on each channel;
- ◆ Short circuit, overload, overheating, and other protections;
- ◆ 6-CH Zones output, Music power switch for each channel zone, USB digital display, touch screen, remote control, bluetooth, FM, USB,SD card;
- ◆ Partition control for relay suction mode, 6-zones knob light switch to show the working status;
- ◆ 2CH microphone & 3CH signal line input, 6 Zones with independent control, each channel can load 75% of the total power, the volume of each way can be independently controlled;
- ◆ With monitoring output, it can also be extended to another power amplifier;
- ◆ 6 LED level indicators;

Public Address Audio System—Wireless desktop transmission series

Wireless audio transmitter



DH-U1000

Function:

- ★Transmission distance: up to 300M in open space and still up to 70M through the wall;
- ★Power supply (adapter): 12v, AC100v-240V/50-60Hz
- ★Transmission frequency: 700MHz-800MHz
- ★Frequency Range: 20Hz-18KHz(± 1dB)
- ★Product Size: 310*190*63 mm
- ★Power consumption: 4VA
- ★THD: <0.5 %
- ★SNR: ≥85dB

Wireless audio sub-control transmitter



DH-U878

Function:

- ★Transmission distance: up to 300M in open space and still up to 70M through the wall;
- ★Power supply (adapter): 12v, AC100v-240V/50-60Hz
- ★Transmission frequency: 700MHz-800MHz
- ★Frequency Range: 20Hz-18KHz(± 1dB)
- ★Product Size: 310*190*63 mm
- ★Power consumption: 4VA
- ★THD: <0.5 %
- ★SNR: ≥85dB

Various Applications

Shops, supermarkets, cafes, restaurants, gyms, dance studios, offices, meeting rooms, living rooms and other Spaces



N pieces transmitters can be in daisy chain



Public Address Audio System—Wireless wall-mounted transmission series

Wireless audio transmitter



T-1 1A/T-11B <2-frequency>

Function:

- ★Transmission distance: up to 300M in open space and still up to 70M through the wall;
- ★Power supply (adapter): 12v, AC100v-240v/50-60Hz
- ★Transmission frequency: 700MHz-800MHz
- ★Frequency Range: 20Hz-18KHZ(±1dB)
- ★Product Size: 310*190*63mm
- ★Power consumption: 4VA
- ★THD: <0.5 %
- ★SNR: =85dB

Wireless audio sub-control transmitter



2-CH zones, volume independent control

DH-U838

Function:

- ★Transmission distance: up to 300M in open space and still up to 70M through the wall;
- ★Power supply (adapter): 12v, Dc9v-12V/1500mA
- ★Transmission frequency: 700MHz-800MHz
- ★Frequency Range: 20Hz-20KHz(± 1dB)
- ★Product Size: 280*203*6 5mm
- ★Power consumption: 4 vA
- ★THD: <0.2%
- ★SNR: ≥85dB

Various Applications

Shops, supermarkets, cafes, restaurants, gyms, dance studios, offices, meeting rooms, living rooms and other Spaces

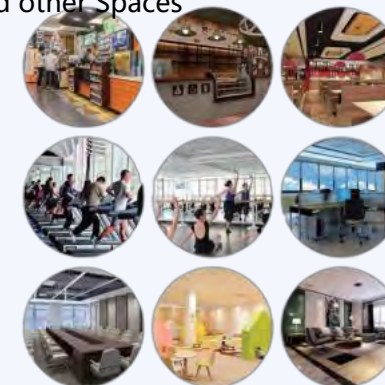

N pieces transmitters can be in daisy chain



Public Address Audio System—Active Speaker Series



Speaker Size: 6.5" Full frequency
 Rated Impedance: 8Ω
 Frequency Range: 20HZ-20KHZ
 Rated Power: DC9V (≤9V)
 Rated Power: 10-15w
 SNR: ≥75dB
 Range: 10000 m²
 Hole for mounting: 165mm
 External Size: 192*78mm



Active narrow side ceiling speaker



TMA-100A/TMA-100B
 (Regular) (Coaxial)



B&W

Speaker Size: 4"*1+3" tweeter
 Rated Impedance: 8Ω
 Frequency Range: 20HZ-20KHZ
 Rated Power: DC9V (≤9V)
 Rated Power: 15-20w
 SNR: ≥75dB
 Range: 10000m²
 Size: 150*210*130mm



Pure sound
 No noise, digital
 lossless transmission
 and reception

TMA-103
Active speaker for conference



Speaker Size: 5.5" LMF + 3" tweeter
 Rated Impedance: 8Ω
 Frequency Range: 20HZ-20KHZ
 Rated Power: 9v
 Rated Power: 20-30w
 SNR: ≥75dB
 Range: 10000 m²
 Size: 325*170*160mm



MP3-732
Active speaker for cinema



Speaker Size: 5" coaxial tweeter
 Rated Impedance: 8Ω
 Frequency Range: 20HZ-20KHZ
 Rated Power: DC9V (≤9V)
 Rated Power: 20-30w
 SNR: ≥75dB
 Range: 10000m²
 Size: 260*225*105mm



TMA-104
Wall-Mounted Active speaker for cinema



Speaker Size:
 5.5" LMF+3" tweeter
 Rated Impedance: 8Ω
 Frequency Range: 20HZ-20KHZ
 Rated Power: DC9V (≤9V)
 Rated Power: 10-15w
 SNR: ≥75dB
 Range: 10000 m²
 Size: 200*170*80mm



B&W

TMA-105
Active speaker for conference



20W 30W 40W

TMA-106
Active column speaker



Speaker Size: 4" LMFx2
 Rated Impedance: 8Ω
 Frequency Range: 20HZ-20KHZ
 Rated Power: DC9V
 Rated Power: 25w
 SNR: ≥75dB
 Range: 10000 m²
 Size: 360*430mm



R&Y&G
 3 colors for choice

TMA-107
Active outdoor garden speaker



Real wireless speaker

Only power on and wireless reception within 70m

Speaker Size: 6.5" LMF+3" tweeter
 Rated Impedance: 8Ω
 Frequency Range: 20HZ-20KHZ
 Rated Power: DC9V
 Rated Power: 30w
 SNR: ≥75dB
 Range: 10000 m²
 Size: 350*225*160mm



TMA-108
Active wall mounted speaker

Public Address Audio System——PREAMP/Amplifier



PREAMP

Model No.	TPA-201	
Microphone Input	600ohms (Ω) , 10mV (-54dBV) , Unbalanced	
Input&Output	3input&2output	
Frequency Range	60Hz-18KHz	
SNR	Microphone:65dB , Line:85dB	
THD	<0.2% (Rated Power)	
Voltage	AC220V \pm 10% 50Hz~60Hz	
Size (mm)	480 \times 390 \times 90	
Functions	<ul style="list-style-type: none"> ◆ 10-CH input(5-CH Mic, 3-CH sig Line, 2-CH Emergency input); ◆ The treble and bass are adjusted independently; ◆ The volume control for each input channel independently; ◆ Buffer Switch on/off, delay output protection function; ◆ Emergency audio signal input without volume adjustment, automatic to 30dB; ◆ 3 levels priority design: MIC1 is the highest priority, emergency audio signal (EMC1, 2) is the second level,MIC2, 3, 5T and line (AUX1, 2, 3) is the third level 	<ul style="list-style-type: none"> ◆ 8-CH independent input, and each channel can independently amplify and adjust the volume; ◆ 1 set of Microphone input, arbitrary selection of 8 sets of output; ◆ With 8-CH (area) arbitrary combination, paging function; ◆ Microphone is the highest priority, and the forced entry priority function for any emergency audio signal input;

Public Address Audio System——PREAMP/Amplifier

Amplifier



(250W-2500W Brushed aluminum panel)

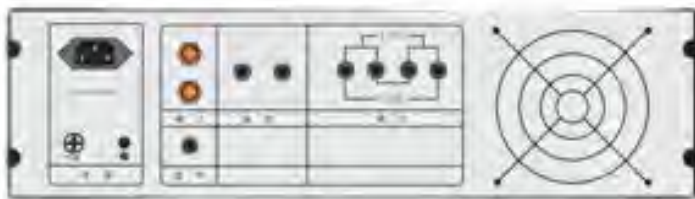

Model No.	TPB-9250/TPB-9350/TPB-9500/TPB-9650/TPB-9800/TPB-1000/TPB-1500/TPB-2000/TPB-2500	
Rated Power	250w/350w/500w/650w/800w/1000w/1500w/2000w/2500w	
Voltage	120V、240V、Monitor output 4V	
Frequency Range	40Hz-16KHz <1dB	
SNR	Microphone input:≥84dB	
THD	≤0.2%	
Voltage	AC220V±10% 50Hz~60Hz	
Chassis	2U	3U
Functions	<ul style="list-style-type: none"> ➤ Dual channel input ➤ LED indicators ➤ RCA jack and XLR jack for easy connection; ➤ Output short-circuit, overload, overheating, anti-lightning and saturation distortion alarm protection 	

Public Address Audio System—Digital intelligent timing player

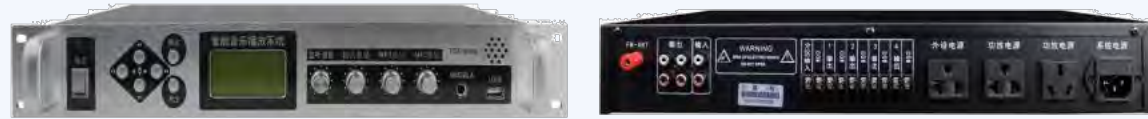

TCE-8200-512M
Digital intelligent timing player MDI 1.5U



TCE-820-8G
Digital intelligent timing player computer programming 2U



TCE-820B-16G Color display/Touch screen
Digital intelligent timing player computer programming 2U
(Radio&recording function)

Remote Control Distance 500-800m Microphone Volume automatically activates amplifier

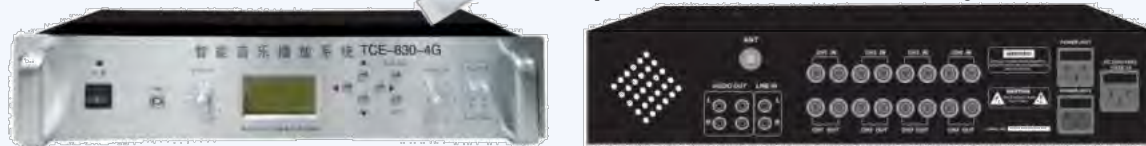

TCE-830-4G
Remote control intelligent timing player for school computer programming 2U
(Radio&recording function)

Functions:

- ◆ Chinese&English menu ;
- ◆ 4.3"TFT RGB true color display;
- ◆ Industrial resistance touch screen, reliable performance, simple operation;
- ◆ Support automatic lock screen function, save energy, extend screen life;
- ◆ Support lossless and various decoding formats :MP3, MP2, MP1, WMA, APE, FLAC, AC3, DTS, RA, AAC, AMR, ATRC, WAV;
- ◆ Support large capacity TF card and U disk;
- ◆ Support music automatic sorting function, no need for special row number software;
- ◆ Support ten sets of schedule procedures, each set can make 999 timing;
- ◆ Each time can be specified to play, loop play, random play, etc. 10, support computer editing timing program;
- ◆ Built-in FM radio function, easy to listen to radio programs; Intelligent speech recognition technology, microphone excitation open power amplifier sensitive and fast;
- ◆ Super load capacity, each power socket can load 1000W power amplifier;
- ◆ The power socket can control the switch respectively, support 6+1 partition;
- ◆ Support output power sequencer short circuit signal function;
- ◆ Support line input switch function;
- ◆ Support short circuit alarm signal input function;
- ◆ Support firmware online upgrade function;
- ◆ Support extended remote control function. (a separate paid module, support 9 songs on demand and partition control);
- ◆ Support the expansion of satellite timing function. (need to buy another module, automatic calibration);

Public Address Audio System—— Stereo power Amplifier



MC-80(8-CH)



MC-60(6-CH)



MC-120(12-CH)



DH-8800 (4x150w)
4-CH zones volume control



DH-4700 (4x200w)
4-CH zones output



MD-800 (2x300w)
2-CH zones output



AV-2327 (4x150w) with ECHO
Cinema Stereo Power Amplifier



H-301
H-302
H-303
H-304

Model No.	DH-8800	DH-4700	MD-800
Zone Channel	4-CH Constant resistance amplifier	4-CH Constant resistance amplifier	8-CH integrated Mixing Console & Amplifier
Power/impedance	4x150w	4x200w	2x300w
Output Channel	4-CH zones volume control	4-CH zones output	2-CH zones output
Microphone Input	Bluetooth & USB & Microphone input	Bluetooth & USB & Microphone input	Bluetooth & USB & Microphone input
Chassis	3U	3U	/
Size(mm)	420x128x330	430x290x120	480x400x110

Model No.	H-301	H-302	H-303	H-304	H-305	H-306	H-307	H-308
Rated Power	2x200W	2x250W	2x300W	2x400W	2x500W	2x600W	2x800W	2x1000w
Frequency Range	20Hz-20KHz±0.5dB							
THD	<0.05%							
Input impedance	>10KQ							
Rate of voltage rise	<40V/us							
Input/S.P.L	775m (dB)							
SNR	>105dB							
Stereo crosstalk	<-75dB							
Power	~220V±10%/50Hz							
Size	482×395×88mm(L×W×H)							

Public Address Audio System—Digital Intelligent Broadcast Peripheral Equipment

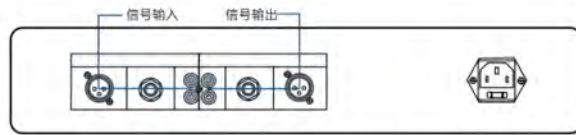

TCE-810 Digital Equalizer

- ◆ 31-band EQ, built-in high-pass filter unit 1.25 times visual range, 30-channel sound frequency point fine adjustment;
- ◆ Low noise bandwidth, effectively improve the quality of the system sound source with gain compensation;
- ◆ Balancing/Pass-through Optional;

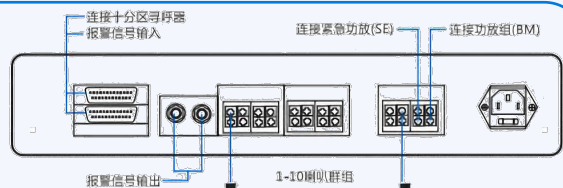

TCE-850-10CH/TCE-850-16CH Digital Partition

- ◆ 10-CH /16-CH independent partition selection switch, partition arbitrary switch, non-interference;
- ◆ 2 signal inputs, including 4 program inputs and one priority input;
- ◆ Manual paging alarm strong cut function;
- ◆ Partition working status display;
- ◆ The total control power capacity of the partition can reach 1.5KW;
- ◆ All-area Switch on/off;
- ◆ Double relay simultaneously; double-cut control circuit, channel isolation $\geq 80\text{dB}$, to solve the cross-talk between channels and other problems;

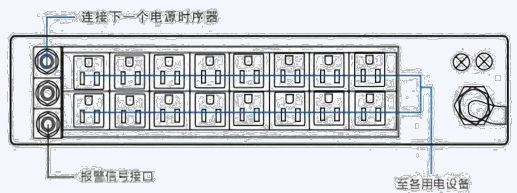

TCE-860-10CH/TCE-860-16CH Digital Sequencer

- ◆ After shutdown, completely stop the output;
- ◆ Safety lock for manual emergency control;
- ◆ Amplifiers and speakers against power shocks;
- ◆ The maximum capacity of each channel socket is 3KVA, the total capacity is 6KVA;
- ◆ Turn on/off 10/16-CH devices in this order to protect the power grid from shocks;
- ◆ The electromechanical input cable is directly connected with the industrial electrical automatic air switch;
- ◆ With emergency trigger interface (when the machine detects the short-circuit activation signal, automatically turn on the power supply in sequence, after the short-circuit signal is eliminated, automatically turn off the power supply in sequence);

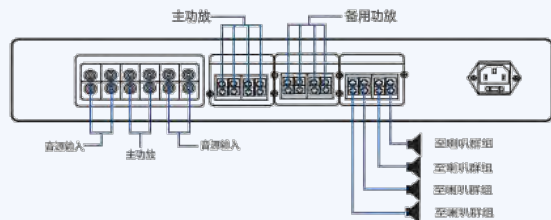

TCE-870 Digital master/slave power amplifier

- ◆ 4 independent channels for 4 master amplifiers /4 standby amplifiers
- ◆ Each channel automatically detects and implements master/standby power amplifier switching
- ◆ Status display

Public Address Audio System——Digital Intelligent Broadcast Peripheral Equipment

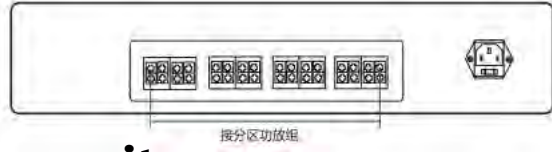

TCE-880 Digital monitor

- ◆ Automatic loop monitoring;
- ◆ Touch button;
- ◆ 16-CH input, each channel are available;
- ◆ Built-in broadband speaker;
- ◆ Monitor channel digit prompt;



TCE-890 Digital signal distributor

- ◆ 2 stereo signal input, 18 stereo signal output;
- ◆ 1 mono signal input, 36 mono signal output;
- ◆ Stereo 10 unit level LED indicator, two audio sources can be selected;
- ◆ Manual switching function;
- ◆ Stereo/mono conversion, easy signal connection, matching signal output;

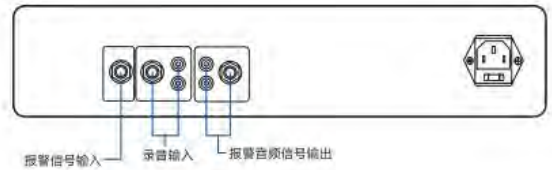

TCE-910 Digital alarm

- ◆ Microcomputer control, light touch button;
- ◆ 1-minute IC digital recording;
- ◆ Two alarm modes: manual/automatic;

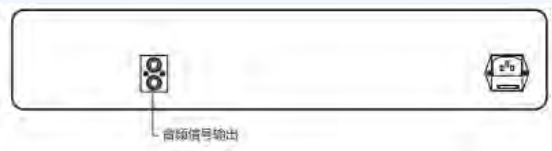

TCE-960 Digital MP3/DVD player

- ◆ Autoplay on power-on;
- ◆ Support DVD/MP3;

Public Address Audio System——Digital Intelligent Broadcast Peripheral Equipment



TCE-970 Digital Tuner

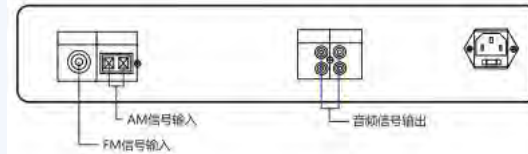

- ◆ AM/FM stereo two-band reception, automatic search reception storage function;
- ◆ 99 radio frequency memory in AM/FM bands;
- ◆ Radio frequency automatic scan receive storage function;



TCE-1000 Digital telephone interface

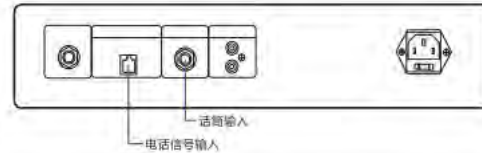

- ◆ Touch button;
- ◆ With automatic phone connection function;
- ◆ Preferred for conference calls;

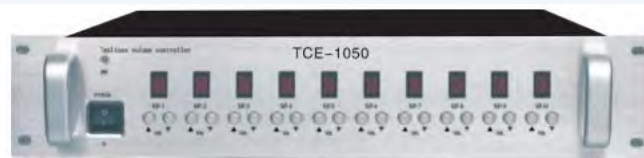

TCE-1050 10-Partition volume controller

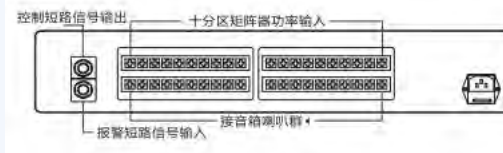

- ◆ Industrial single-chip microcomputer control, simple and reliable operation;
- ◆ 10 channel, 7 band volume adjustment, dual line input without crosstalk interference;
- ◆ Each control input and output power can reach 200W;
- ◆ Alarm trigger function, and then the volume is turned to the maximum state under this priority;

Public Address Audio System—Horn Loudspeaker Series



Early warning horn speaker

Model No.:FK-600
Rated Power:600w
Size:720×460×620mm
Weight:25kg
Input:8Ω



Directional horn speaker
<Constant voltage/Constant resistance>

Model No.:FK-300
Rated Power:300w
Size:490× 480 × 260mm
Weight:23kg
Input:8Ω/110V

HORN SPEAKER KIT



- Air defense early Warning
- Mine early Warning
- Forest early Warning
- Coastal defense early Warning
- Water conservancy early warning



Parking lot horn speaker

Model No.:KD-729
Rated Power:50W
Size:366× 230× 272mm
Weight:2kg
Input:70V/110V

Public Address Audio System——Horn Loudspeaker Series



Horn loudspeaker for countryside

Model No.:FK-100
Rated Power:100w
Size:320 × 300 x
300mmWeight:3kg
Input:70V/110V



Horn loudspeaker for administration corridor

Model No.:FK-50
Rated Power:50w
Size:205×285×280mm
Weight:1.5kg
Input:70V/110V

- ✓ Hanging
- ✓ Orientable
- ✓ Surface mount
- ✓ Support Constant voltage&Constant resistance

Public Address Audio System—Long-distance horn loudspeaker

<Constant voltage/Constant resistance>

The long-distance horn loudspeaker has super penetrating power and good high and low frequency characteristics. The sound is transparent and bright, ideal for music and voice restoration. It's best application for plazas, stations, wharves, highways, stadiums, schools, parks, playgrounds, mines, forest farms and other large public places.

HORN LOUDSPEAKER

YH180-8"
180W



YH250-10"
250w



YH350-12"
350w



YH500-15"
500W

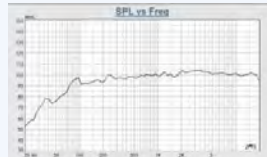
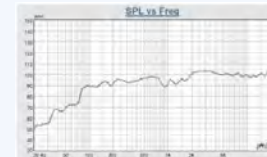
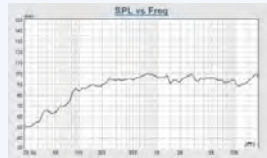

- Air defense early Warning
- Mine early Warning
- Forest early Warning
- Coastal defense early Warning
- Water conservancy early warning
- Special for Music fountain

Installation precautions:

1. Use the holes reserved around the frame when hoisting. Do not remove loose screws on the box; otherwise, water leakage may occur and the sound box may be damaged.
2. When installing the horn speaker, it must be tilted down (ground direction) more than 5 degrees to prevent rain from seeping into the net board and flowing back into the box to damage the horn.

Public Address Audio System—Horn Loudpeaker Series

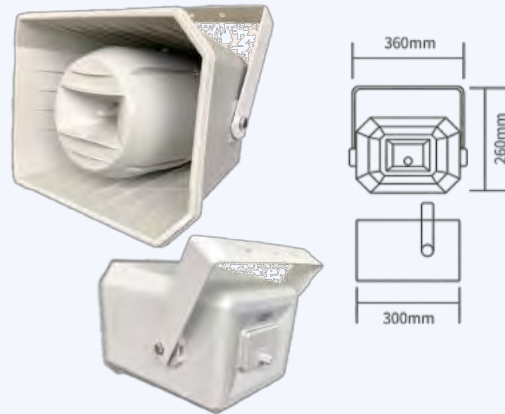

**Horn Speaker
KD-516**

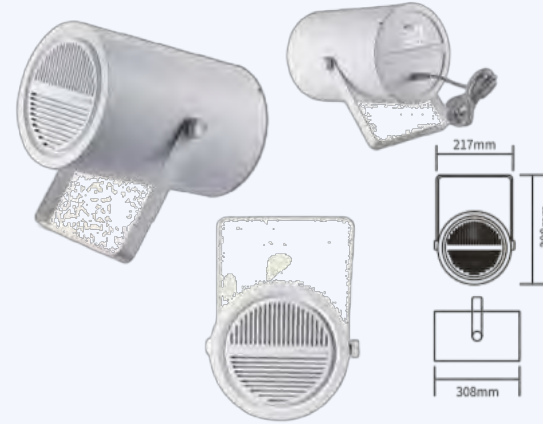

**Directional horn speaker
KD-517**

SPECIFICATION	
Rated Power	100w
Constant voltage input	70v-100v
S.P.L	90dB
Frequency Range	90-16000Hz
Speaker	φ5"(H)
External Size	360x260x300mm

SPECIFICATION	
Rated Power	30w
Constant voltage input	70v-100v
S.P.L	90dB
Frequency Range	90-16000Hz
Speaker	φ5.5"(H)
External Size	80x80x270mm

Public Address Audio System—Horn Loudspeaker Series



**Projector & aluminum horn speaker
(Constant voltage)
KD-719B**

SPECIFICATION	
Rated Power	50w
Constant voltage input	70v-100v
S.P.L	90dB
Frequency Range	90-16000Hz
Speaker	φ3" tweeter
External Size	320x300x300mm

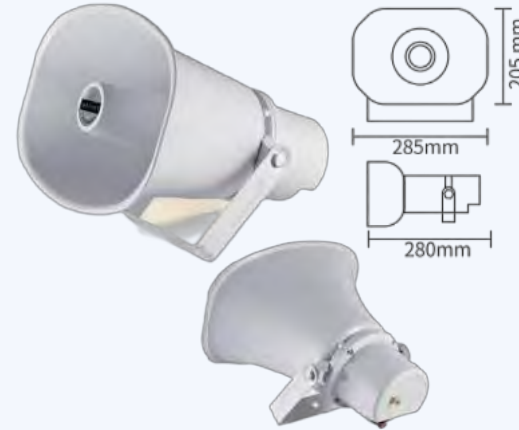

**Projector horn speaker
KD-721
(Customized Constant voltage&Constant resistance)**

SPECIFICATION	
Rated Power	30w
Constant voltage input	70v-100v
S.P.L	90dB
Frequency Range	90-16000Hz
Speaker	φ6.5" + 3" tweeter
External Size	280x140x208mm

Public Address Audio System—Horn Loudspeaker Series

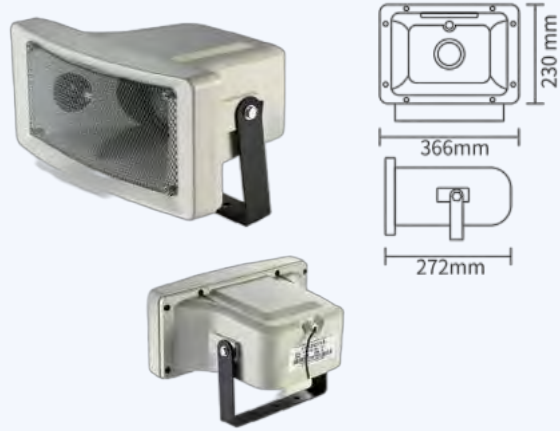

**Projector horn speaker
KD-729**

(Constant voltage/Constant resistance for

SPECIFICATION

Rated Power	50w
Constant voltage input	70v-100v
S.P.L	90dB
Frequency Range	90-16000Hz
Speaker	φ5.5"+3" tweeterx2
External Size	366x230x272mm



**Surface mounted/wall mounted/hanging speaker
KD-731 (B&W)**

SPECIFICATION

Rated Power	20w
Constant voltage input	70v-100v
S.P.L	90dB
Frequency Range	90-16000Hz
Speaker	φ5.5" Coaxial
External Size	167x217mm

Public Address Audio System—Ceiling Speaker Series

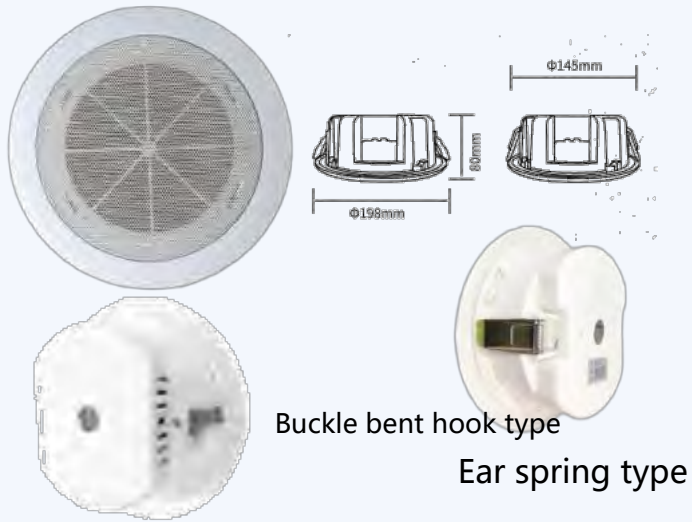

KS-801 (Fire warning)

SPECIFICATION	
Rated Power	3w
Constant voltage input	70v-100v
S.P.L	90dB
Frequency Range	90-16000Hz
Hole for mounting	φ145mm
External Size	φ198×80mm

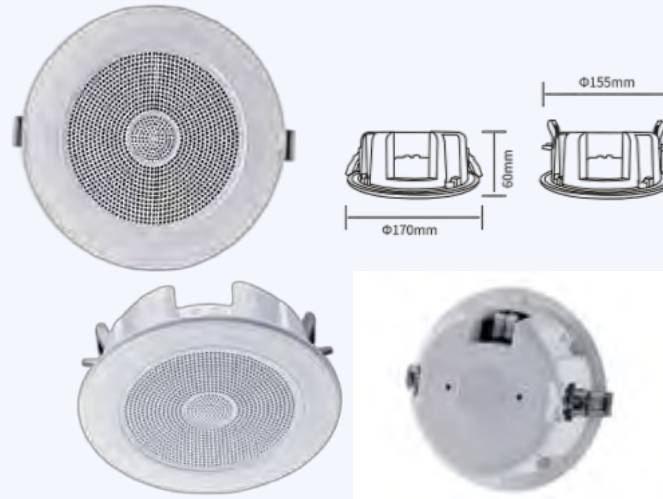

KS-801B (Fire warning)

SPECIFICATION	
Rated Power	3w
Constant voltage input	70v-100v
S.P.L	90dB
Frequency Range	90-16000Hz
Hole for mounting	φ155mm
External Size	φ170×60mm

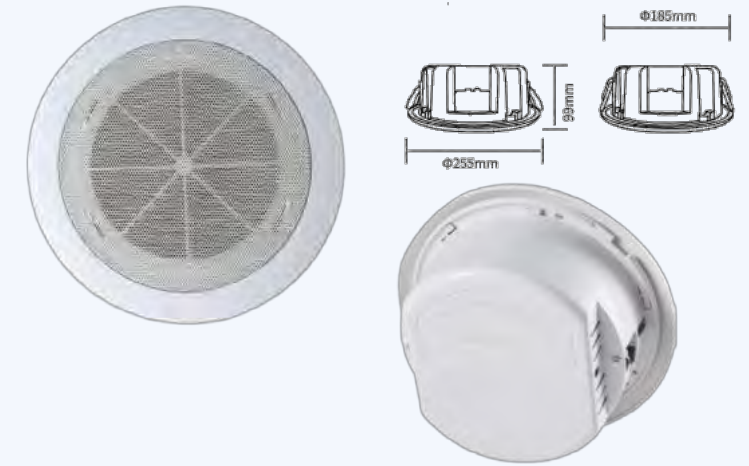

KS-802 (Fire warning)

SPECIFICATION	
Rated Power	3w-6w
Constant voltage input	70v-100v
S.P.L	90dB
Frequency Range	90-16000Hz
Hole for mounting	φ185mm
External Size	φ255×99mm

Public Address Audio System——Ceiling Speaker Series

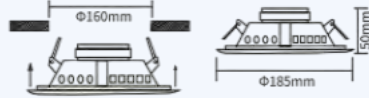
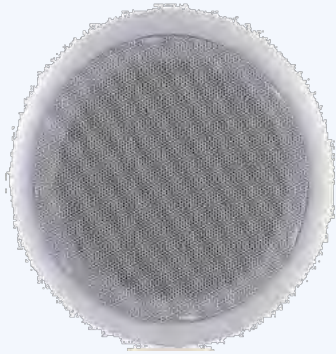

KS-803 (New broadside)

SPECIFICATION	
Rated Power	3w
Constant voltage input	70v-100v
S.P.L	90dB
Frequency Range	90-16000Hz
Hole for mounting	φ160mm
External Size	φ185X50mm



KS-803C (Hot-selling)

SPECIFICATION	
Rated Power	3w
Constant voltage input	70v-100v
S.P.L	90dB
Frequency Range	90-16000Hz
Hole for mounting	φ160mm
External Size	φ185X50mm

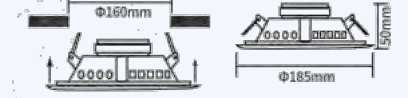

KS-8000 (New narrowside)

SPECIFICATION	
Rated Power	3w
Constant voltage input	70v-100v
S.P.L	90dB
Frequency Range	90-16000Hz
Hole for mounting	φ160mm
External Size	φ185X50mm

Public Address Audio System——Ceiling Speaker Series

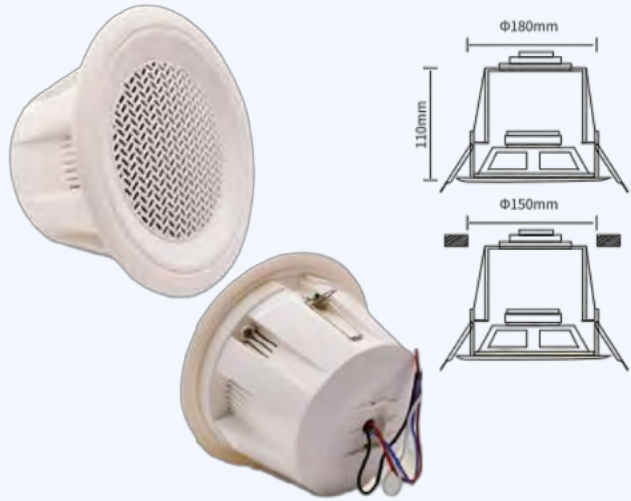

KS-804

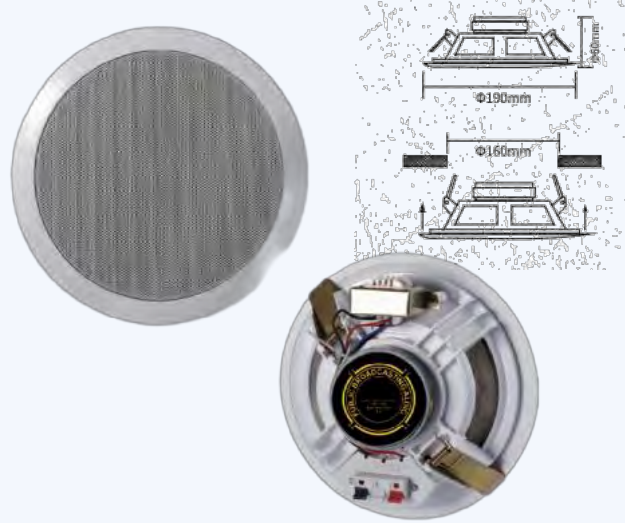

KS-805



KS-806

SPECIFICATION	
Rated Power	3w-10w
Constant voltage input	70v-100v
S.P.L	90dB
Frequency Range	90-16000Hz
Hole for mounting	φ150mm
External Size	φ180×110mm

SPECIFICATION	
Rated Power	3w-10w
Constant voltage input	70v-100v
S.P.L	90dB
Frequency Range	90-16000Hz
Hole for mounting	φ160mm
External Size	φ190×60mm

SPECIFICATION		
Rated Power	KS-806A	KS-806B
Constant voltage input	3w-10w	
S.P.L	70v-100v	
Frequency Range	90dB	
Hole for mounting	90-16000Hz	
External Size	φ145mm	φ180mm
Rated Power	φ178×68mm	φ225×99mm

Public Address Audio System——Ceiling Speaker Series

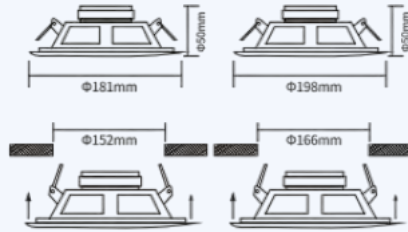
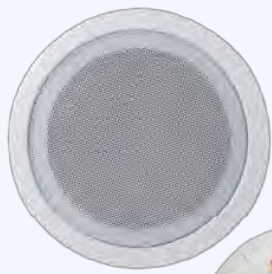

KS-808A/B

SPECIFICATION		
Model No.	KS-808A	KS-808B
Rated Power	3w-10w	
Constant voltage input	70v-100v	
S.P.L	90dB	
Frequency Range	90-16000Hz	
Hole for mounting	φ152mm	φ166mm
External Size	φ181×50mm	φ198×50mm

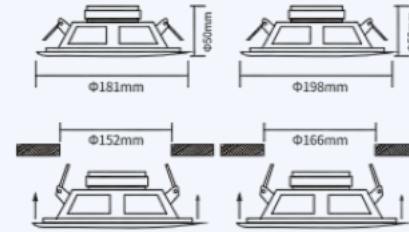
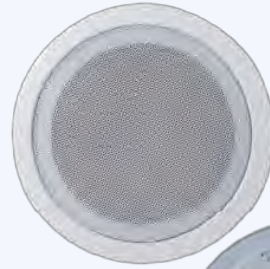

KS-809A/B

SPECIFICATION		
Model No.	KS-809A	KS-809B
Rated Power	3w-10w	
Constant voltage input	70v-100v	
S.P.L	90dB	
Frequency Range	90-16000Hz	
Hole for mounting	φ152mm	φ166mm
External Size	φ181×50mm	φ198×50mm

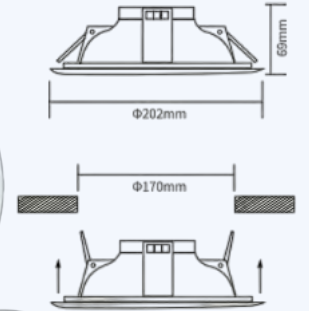

KS-810

SPECIFICATION	
Rated Power	3w-10w
Constant voltage input	70v-100v
S.P.L	90dB
Frequency Range	90-16000Hz
Hole for mounting	φ170mm
External Size	φ202×69mm

Public Address Audio System——Ceiling Speaker Series



KS-811 (Surface mount)



KS-811B (Surface mount)
ABS material



KS-811C
(New Surface mount)

SPECIFICATION	
Rated Power	3w
Constant voltage input	70v-100v
S.P.L	90dB
Frequency Range	90-16000Hz
Hole for mounting	Surface mounted
External Size	φ180×70mm

SPECIFICATION	
Rated Power	3w
Constant voltage input	70v-100v
S.P.L	90dB
Frequency Range	90-16000Hz
Hole for mounting	Surface mounted
External Size	φ180×63mm

SPECIFICATION	
Rated Power	3w
Constant voltage input	70v-100v
S.P.L	90dB
Frequency Range	90-16000Hz
Hole for mounting	Surface mounted
External Size	φ219×75mm

Public Address Audio System——Ceiling Speaker Series



KS-811D

(New surface mounted, metal material)

SPECIFICATION	
Rated Power	20w
Constant voltage input	70v-100v
S.P.L	90dB
Frequency Range	90-16000Hz
Hole for mounting	Surface mounted
External Size	φ138×140mm

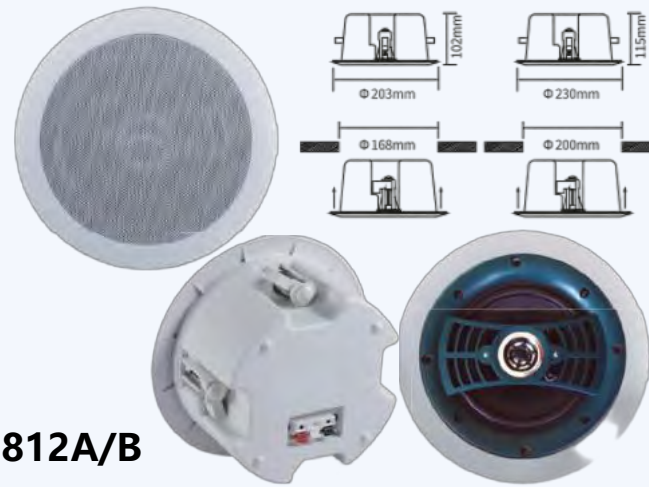

KS-812A/B

SPECIFICATION		
Model No.	KS-812A	KS-812B
Rated Power	10W~20W	20W~30W
Constant voltage input	70v-100v	
S.P.L	90dB	
Frequency Range	90-16000Hz	
Hole for mounting	φ168mm	φ200mm
External Size	φ203×102mm	φ230×115mm



KS-813

(Waterproof for bathroom/plastic material)

SPECIFICATION	
Rated Power	1.5W~3W
Constant voltage input	70v-100v
S.P.L	90dB
Frequency Range	90-16000Hz
Hole for mounting	φ100mm
External Size	φ120×80mm

Public Address Audio System——Ceiling Speaker Series



KS-814 (Waterproof for bathroom)

SPECIFICATION	
Rated Power	1.5W~3W
Constant voltage input	70v-100v
S.P.L	90dB
Frequency Range	90-16000Hz
Hole for mounting	φ101mm
External Size	φ127×90mm



KS-815 (Waterproof for bathroom)

SPECIFICATION	
Rated Power	1.5W~3W
Constant voltage input	70v-100v
S.P.L	90dB
Frequency Range	90-16000Hz
Hole for mounting	φ90mm
External Size	φ98×85mm



KS-817 (New narrowside)

SPECIFICATION	
Rated Power	5w-10w
Constant voltage input	70v-100v
S.P.L	90dB
Frequency Range	90-16000Hz
Hole for mounting	φ165mm
External Size	φ185×80mm

Public Address Audio System——Ceiling Speaker Series

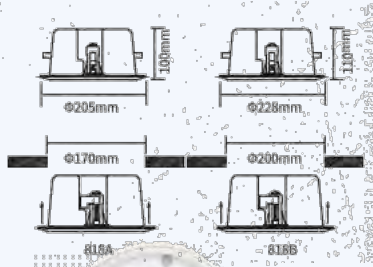

KS-818A/B
(Constant voltage
Coaxial narrowside)

SPECIFICATION

Model No.	818A	818B
Rated Power	10W~20W	20W~30W
Constant voltage input	70v-100v	
S.P.L	90dB	
Frequency Range	90-16000Hz	
Hole for mounting	φ170mm	φ200mm
External Size	φ205×100mm	φ228×110mm

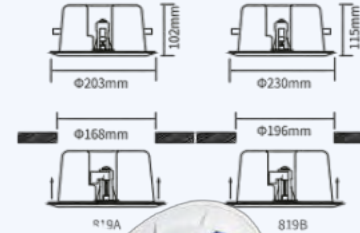

KS-819A/B
(Constant voltage
coaxial tweeter)

SPECIFICATION

Model No.	819A	819B
Rated Power	10W~20W	20W~30W
Constant voltage input	70v-100v	
S.P.L	90dB	
Frequency Range	90-16000Hz	
Hole for mounting	φ168mm	φ196mm
External Size	φ203×102mm	φ230×115mm

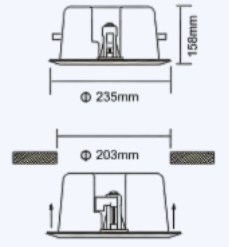
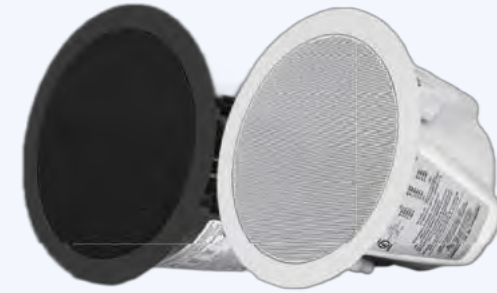

**KS-822
B&W**
(Constant voltage&Constant resistance
adjustable,coaxial tweeter)

SPECIFICATION

Rated Power	30w-40w
Constant voltage input	70v-100v/8Ω
S.P.L	90dB
Frequency Range	90-16000Hz
Hole for mounting	φ203mm
External Size	φ235×158mm

Public Address Audio System—Ceiling Speaker Series

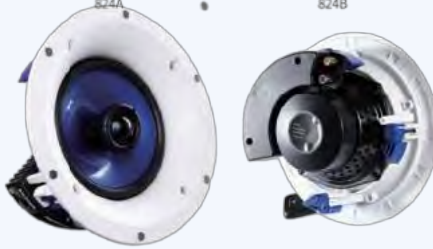
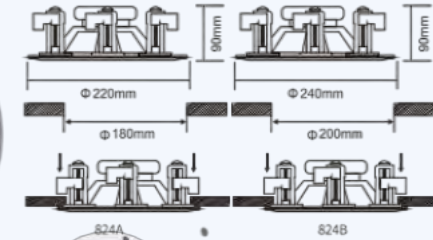

KS-824A/B
(Constant resistance coaxial)

SPECIFICATION

Model No.	824A	824B
Rated Power	20W~30W	30W~40W
Constant voltage input	8Ω	
S.P.L	90dB	
Frequency Range	90-16000Hz	
Hole for mounting	φ180mm	φ200mm
External Size	φ220×90mm	φ240×90mm

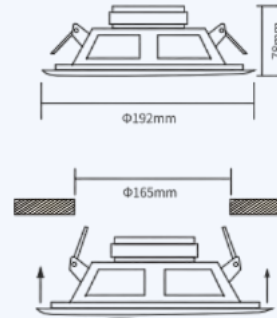

KS-825
(Constant resistance coaxial tweeter)

SPECIFICATION

Rated Power	20w
Constant voltage input	8Ω
S.P.L	90dB
Frequency Range	90-16000Hz
Hole for mounting	φ165mm
External Size	φ192×78mm

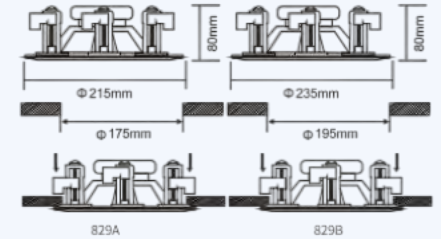

KS-829A/B
(Constant resistance coaxial tweeter)

SPECIFICATION

Model No.	829A	829B
Rated Power	20W	40W
Constant voltage input	8Ω	8Ω
S.P.L	90dB	
Frequency Range	90-16000Hz	
Hole for mounting	φ175mm	φ195mm
External Size	φ215x80mm	φ235x80mm

Public Address Audio System——Ceiling Speaker Series

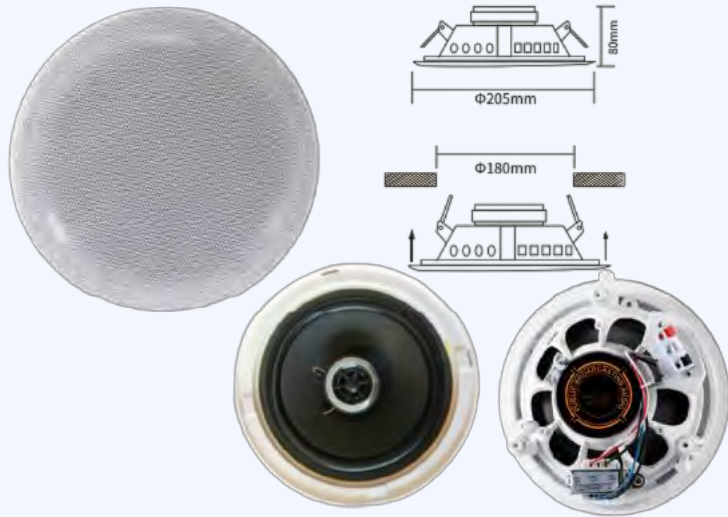

KS-832
(Constant voltage coaxial tweeter)

SPECIFICATION	
Rated Power	20W~30W
Constant voltage input	70v-100v
S.P.L	90dB
Frequency Range	90-16000Hz
Hole for mounting	φ180mm
External Size	φ205×80mm

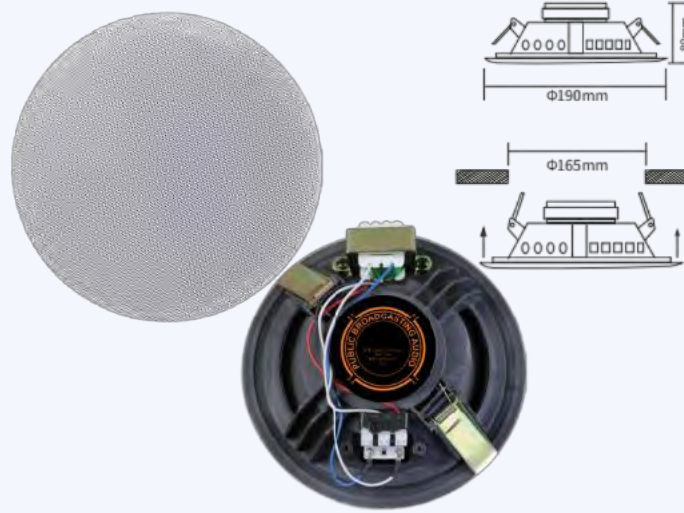

KS-834 (New narrow side)

SPECIFICATION	
Rated Power	5W~15W
Constant voltage input	70v-100v
S.P.L	90dB
Frequency Range	90-16000Hz
Hole for mounting	φ165mm
External Size	φ190×80mm

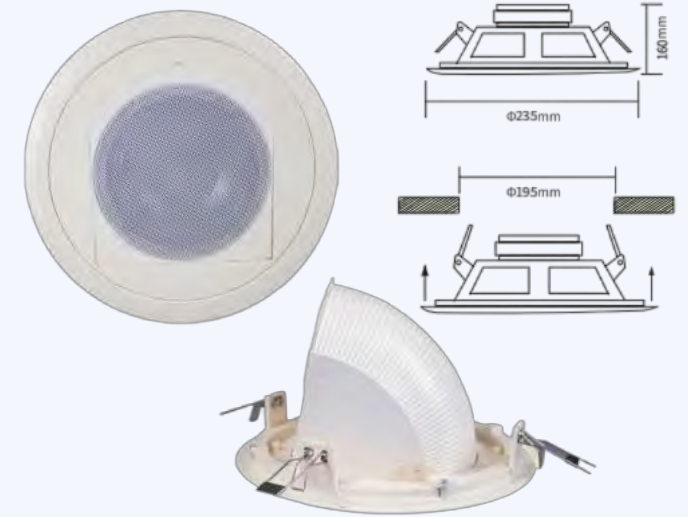

KS-835
(Projector/orientation adjustable)

SPECIFICATION	
Rated Power	10w-20w
Constant voltage input	70v-100v
S.P.L	90dB
Frequency Range	90-16000Hz
Hole for mounting	φ195mm
External Size	φ235×160mm

Public Address Audio System——Ceiling Speaker Series

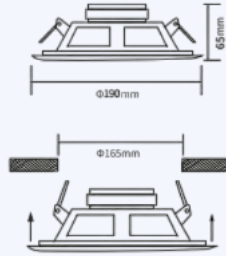

KS-836

(Iron material, narrow side)

SPECIFICATION	
Rated Power	5W~10W
Constant voltage input	70v-100v
S.P.L	90dB
Frequency Range	90-16000Hz
Hole for mounting	φ165mm
External Size	φ190×65mm

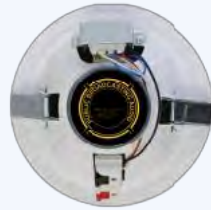
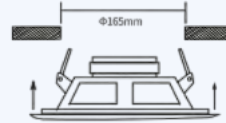
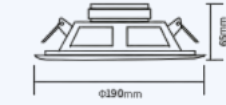
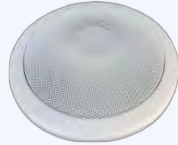

KS-837 (Hot-selling)

concave-convex iron material

SPECIFICATION	
Rated Power	5W~10W
Constant voltage input	70v-100v
S.P.L	90dB
Frequency Range	90-16000Hz
Hole for mounting	φ165mm
External Size	φ190×65mm

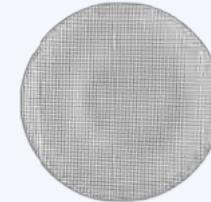
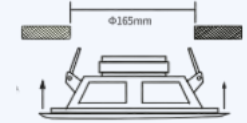
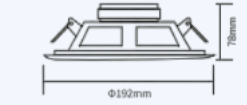
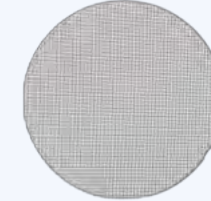

KS-838

(Constant voltage/Constant resistance adjustable, coaxial tweeter)

SPECIFICATION	
Rated Power	20w
Constant voltage input	8Ω/110V
S.P.L	90dB
Frequency Range	90-16000Hz
Hole for mounting	φ165mm
External Size	φ192×78mm

Public Address Audio System——Ceiling Speaker Series

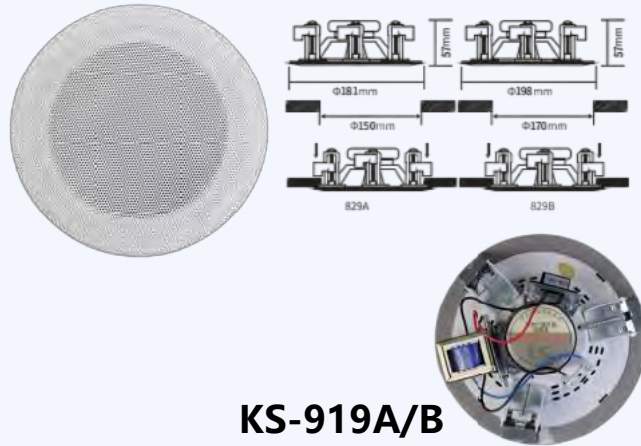

KS-919A/B
(Iron material, narrow side)

SPECIFICATION		
Model No.	919A (5")	919B (6.5")
Rated Power	5-10W	5-10W
Constant voltage input	8Ω	8Ω
S.P.L	90dB	
Frequency Range	90-16000Hz	
Hole for mounting	φ150mm	φ170mm
External Size	φ181x57mm	φ198x57mm

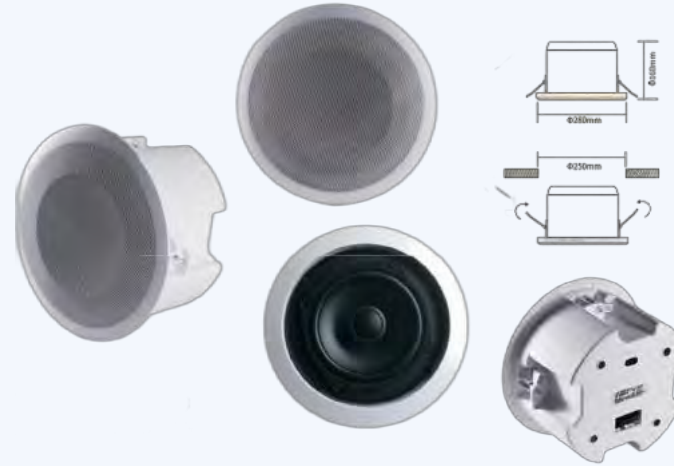

KS-8
(8" large size)

SPECIFICATION	
Rated Power	60w-100w
Constant voltage input	70v-100v
S.P.L	90dB
Frequency Range	90-16000Hz
Hole for mounting	φ250mm
External Size	φ280X160mm



H-0606
(Iron material)

SPECIFICATION	
Rated Power	10w
Constant voltage input	70v-100v/8Ω
S.P.L	90dB
Frequency Range	90-16000Hz
Hole for mounting	φ170mm
External Size	200*80mm

Public Address Audio System——Wall Mounted Speaker Series



**Wall mounted speaker
KD-500**

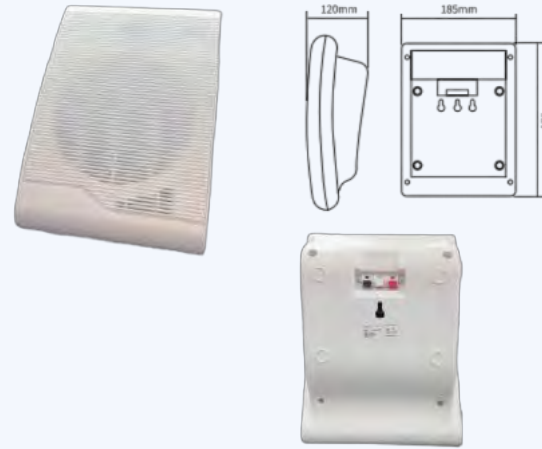

**Wall mounted speaker
KD-500B**

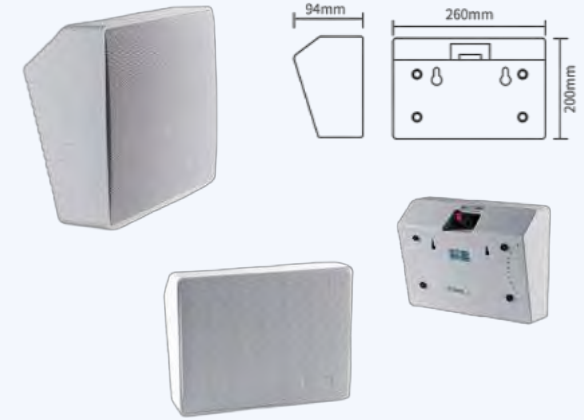

**Wall mounted speaker
KD-501**

SPECIFICATION	
Rated Power	20w
Constant voltage input	70v-100v
S.P.L	90dB
Frequency Range	90-16000Hz
Speaker	φ6.5"+3"tweeter
External Size	275x185x120mm

SPECIFICATION	
Rated Power	5w-10w
Constant voltage input	70v-100v
S.P.L	90dB
Frequency Range	90-16000Hz
Speaker	φ6.5"+3"tweeter
External Size	275x185x120mm

SPECIFICATION	
Rated Power	20w
Constant voltage input	70v-100v
S.P.L	90dB
Frequency Range	90-16000Hz
Speaker	φ4"+3"tweeter
External Size	260x200x94mm

Public Address Audio System—Wall Mounted Speaker Series

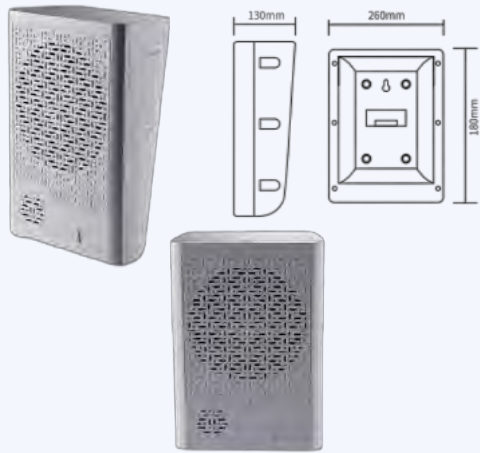

**Wall mounted speaker
KD-502**



**Wall mounted speaker
KD-503 B&W**



**Wall mounted speaker
KD-504 B&W**

SPECIFICATION	
Rated Power	10W~20w
Constant voltage input	70v-100v
S.P.L	90dB
Frequency Range	90-16000Hz
Speaker	φ6.5"+3"tweeter
External Size	260x180x130mm

SPECIFICATION	
Rated Power	20w
Constant voltage input	70v-100v
S.P.L	90dB
Frequency Range	90-16000Hz
Speaker	φ5"+3"tweeter
External Size	260x174x118mm

SPECIFICATION	
Rated Power	20w-30w
Constant voltage input	70v-100v
S.P.L	90dB
Frequency Range	90-16000Hz
Speaker	φ5" coaxial tweeter
External Size	260x225x105mm

Public Address Audio System—Wall Mounted Speaker Series



**Wall mounted speaker for conference
KD-505**

SPECIFICATION	
Rated Power	20w
Constant voltage input	70v-100v
S.P.L	90dB
Frequency Range	90-16000Hz
Speaker	φ5.5" +3" tweeter
External Size	247x155x120mm

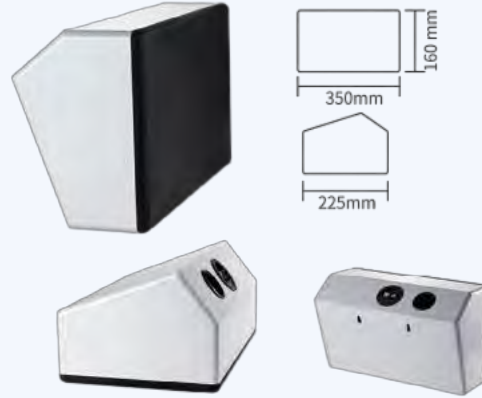

**Wood Wall mounted speaker
KD-506**

SPECIFICATION	
Rated Power	30w
Constant voltage input	70v-100v
S.P.L	90dB
Frequency Range	90-16000Hz
Speaker	φ6.5" +3" tweeter
External Size	350x225x160mm



**Wood Wall mounted speaker
KD-508 (Historical retro style)**

SPECIFICATION	
Rated Power	30w
Constant voltage input	70v-100v
S.P.L	90dB
Frequency Range	90-16000Hz
Speaker	φ5.5" coaxial tweeter
External Size	255x230x105mm

Public Address Audio System——Wall Mounted Speaker Series



Wall mounted speaker for fire warning
KD-509

SPECIFICATION	
Rated Power	3W-6W
Constant voltage input	70v-100v
S.P.L	90dB
Frequency Range	90-16000Hz
Speaker	φ5"
External Size	203x157x65mm



Wall mounted speaker for fire warning
KD-510

SPECIFICATION	
Rated Power	3W-6W
Constant voltage input	70v-100v
S.P.L	90dB
Frequency Range	90-16000Hz
Speaker	φ5"
External Size	190x150x74mm



Wall mounted speaker for conference
(B&W)
KD-511-5"/KD-511-6.5"

SPECIFICATION		
Rated Power	KD-511-5"	KD-511-6.5"
Constant voltage input	20-30W	30-40W
S.P.L	8Ω	8Ω
Frequency Range	90dB	
Mounting Hole Hole for mounting	90-16000Hz	
Speaker	φ5"+3"tweeter	φ6.5"+3"tweeter
Rated Power	245x155x110mm	293x185x130mm

Public Address Audio System——Wall Mounted Speaker Series

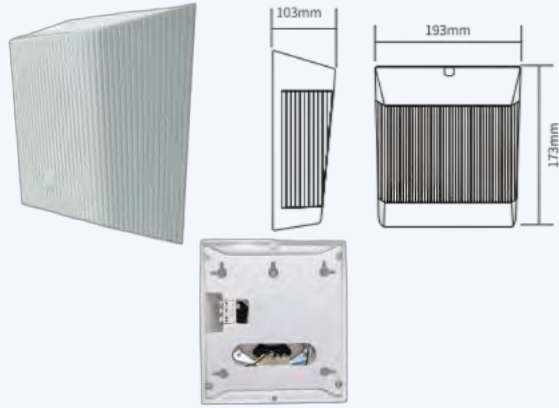

**Wall mounted speaker
KD-512**



**Wall mounted speaker for conference
(Constant voltage/Constant resistance adjustable)
KD-513 B&W**



**Wall mounted speaker for conference
KD-514**

SPECIFICATION	
Rated Power	5W~10w
Constant voltage input	70v-100v
S.P.L	90dB
Frequency Range	90-16000Hz
Speaker	φ4"
External Size	173×193×103m m

SPECIFICATION	
Rated Power	30w
Constant voltage input	70v-100v
S.P.L	90dB
Frequency Range	90-16000Hz
Speaker	φ6.5"+3" tweeter
External Size	215×155×190m m

SPECIFICATION	
Rated Power	30w
Constant voltage input	70v-100v
S.P.L	90dB
Frequency Range	90-16000Hz
Speaker	φ5.5"+3" tweeter
External Size	190×308×217m m

Public Address Audio System—Wall Mounted Speaker Series



**Wood wall mounted speaker
KD-515**

SPECIFICATION	
Rated Power	30w
Constant voltage input	70v-100v
S.P.L	90dB
Frequency Range	90-16000Hz
Speaker	φ6.5" +3" tweeter
External Size	280x140x208mm

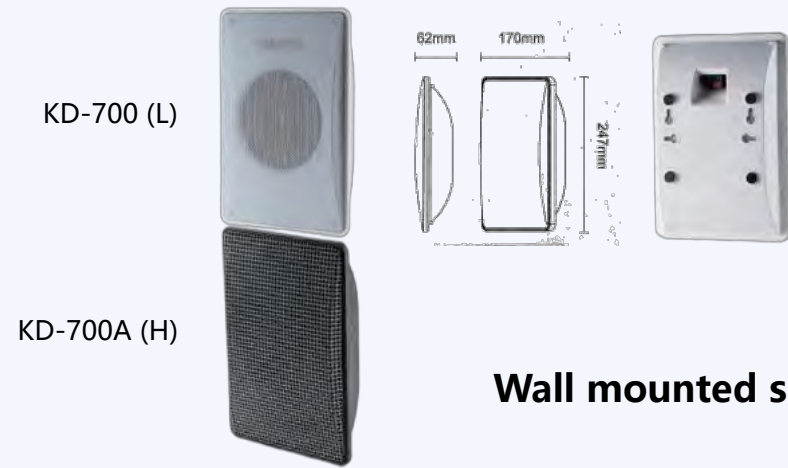

Wall mounted speaker

SPECIFICATION		
Model No.	KD-700	KD-700A
Rated Power	10w	15w
Constant voltage input	70v-100v	
S.P.L	90dB	
Frequency Range	90-16000Hz	
Speaker	φ5" +3" tweeter	φ5.5" +3" tweeter
External Size	247x170x62mm	247x170x62mm

Public Address Audio System—Wall Mounted Speaker Series

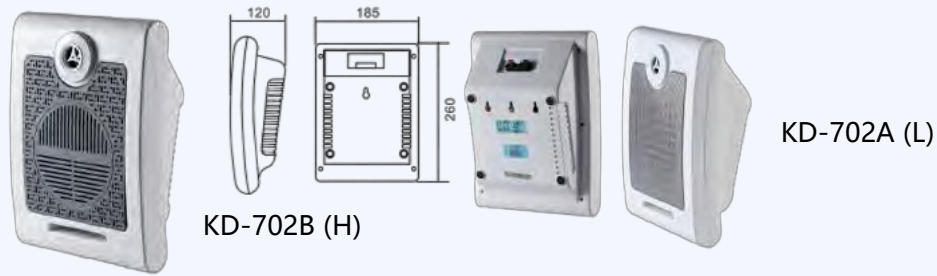

Wall mounted speaker for fire warning
KD-702A (L)
KD-702B (H)

SPECIFICATION		
Model No.	KD-702A	KD-702B
Rated Power	5w	5w~10W
Constant voltage input	70v-100v	
S.P.L	90dB	
Frequency Range	90-16000Hz	
Speaker	φ6.5" +3" tweeter	φ6.5" +3" tweeter
External Size	275x200x108mm	275x200x108mm

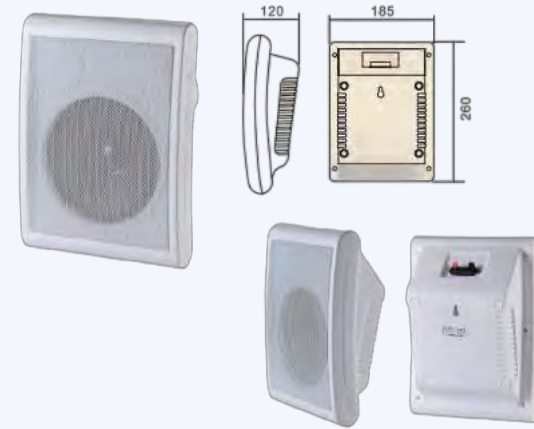

Wall mounted speaker for fire warning
KD-703

SPECIFICATION	
Rated Power	5W
Constant voltage input	70v-100v
S.P.L	90dB
Frequency Range	90-16000Hz
Speaker	φ6.5" +3" tweeter
External Size	275x200x108mm

Public Address Audio System—Wall Mounted Speaker Series

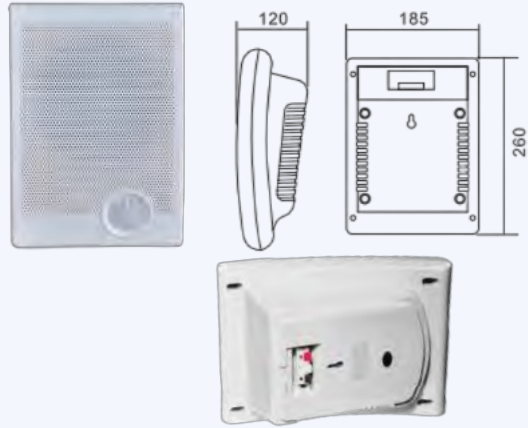

**Wall mounted speaker
KD-704**

SPECIFICATION	
Rated Power	5w~10w
Constant voltage input	70v-100v
S.P.L	90dB
Frequency Range	90-16000Hz
Speaker	φ6.5"+3"tweeter
External Size	260x185x120mm

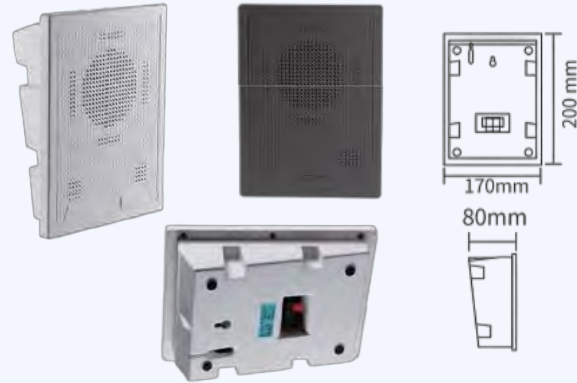

**Wall mounted speaker
KD-705
(Surface mounted/recessed) (B&W)**

SPECIFICATION	
Rated Power	10w~15w
Constant voltage input	70v-100v
S.P.L	90dB
Frequency Range	90-16000Hz
Speaker	φ5.5"+3"tweeter
External Size	200x170x80mm

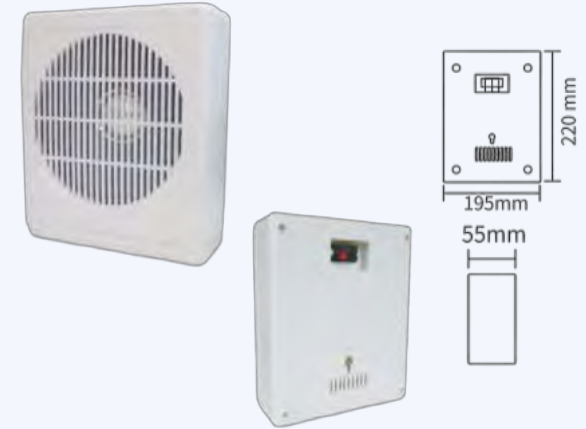

**Wall mounted speaker for fire warning
KD-706**

SPECIFICATION	
Rated Power	3w
Constant voltage input	70v-100v
S.P.L	90dB
Frequency Range	90-16000Hz
Speaker	φ6.5"
External Size	220x195x55mm

Public Address Audio System—Wall Mounted Speaker Series



**Wood wall mounted speaker
KD-707A**



**Wall mounted speaker for conference
KD-708**

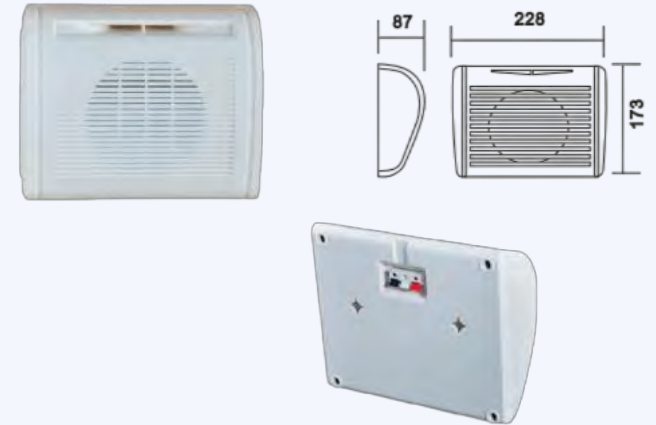

**Wall mounted speaker
KD-709**

SPECIFICATION	
Rated Power	10-15w
Constant voltage input	70v-100v
S.P.L	90dB
Frequency Range	90-16000Hz
Speaker	φ4" +3" tweeter
External Size	220x198x110mm

SPECIFICATION	
Rated Power	10-15w
Constant voltage input	70v-100v
S.P.L	90dB
Frequency Range	90-16000Hz
Speaker	φ4" +3" tweeter
External Size	360x220x110mm

SPECIFICATION	
Rated Power	5-10w
Constant voltage input	70v-100v
S.P.L	90dB
Frequency Range	90-16000Hz
Speaker	φ5"
External Size	228x173x87mm

Public Address Audio System—Wall Mounted Speaker Series

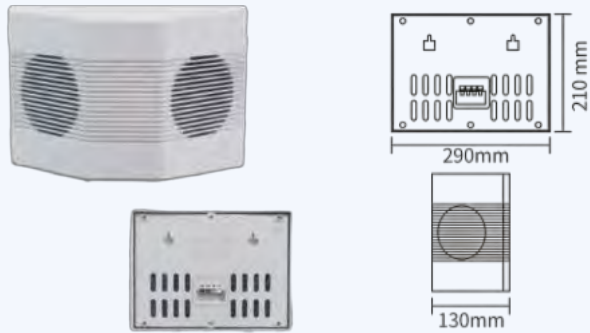

Double-Sided Wall Mounted Speaker

SPECIFICATION	
Rated Power	2x10w
Constant voltage input	70v-100v
S.P.L	90dB
Frequency Range	90-16000Hz
Speaker	φ5"x2
External Size	290x210x130mm



**Wood wall mounted speaker(8")
KD-711**
(Constant voltage/Constant resistance for optional)

SPECIFICATION	
Rated Power	100w
Constant voltage input	70v-100v
S.P.L	90dB
Frequency Range	90-16000Hz
Speaker	φ8"+2x4" tweeter
External Size	320x363x200mm

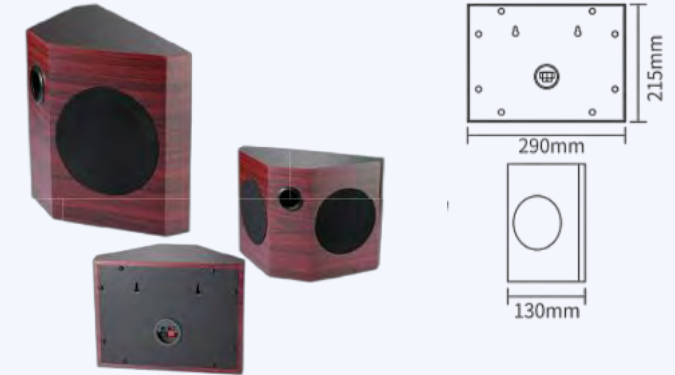

**Wood Double-Sided Wall Mounted Speaker
KD-714**

SPECIFICATION	
Rated Power	2*20w
Constant voltage input	70v-100v
S.P.L	90dB
Frequency Range	90-16000Hz
Speaker	φ5"x2"
External Size	290x130x215mm

Public Address Audio System——Wall Mounted Speaker Series



**Wood wall mounted speaker
KD-715**

SPECIFICATION	
Rated Power	30w
Constant voltage input	70v-100v
S.P.L	90dB
Frequency Range	90-16000Hz
Speaker	φ6.5" +3" tweeter
External Size	280x140x208mm



**Wood wall mounted speaker
MT-716B(W)
MT-717B(B)**

SPECIFICATION	
Rated Power	100w
Constant voltage input	70v-100v
S.P.L	90dB
Frequency Range	90-16000Hz
Speaker	φ5" (H)
External Size	360x260x300mm



**Wall mounted speaker for conference
KD-716-5"
KD-716-6.5"**

SPECIFICATION		
Model No.	KD-716-5"	KD-716-6.5"
Rated Power	20W~30w	30W~40W
Constant voltage input	70v-100v	
S.P.L	90dB	
Frequency Range	90-16000Hz	
Speaker	φ5+3" tweeter	φ6.5" +3" tweeter
External Size	244x185x163mm	298x218x190mm

Public Address Audio System—Wall Mounted Speaker Series



Wall mounted speaker for conference
KD-717-5"
KD-717-6.5"

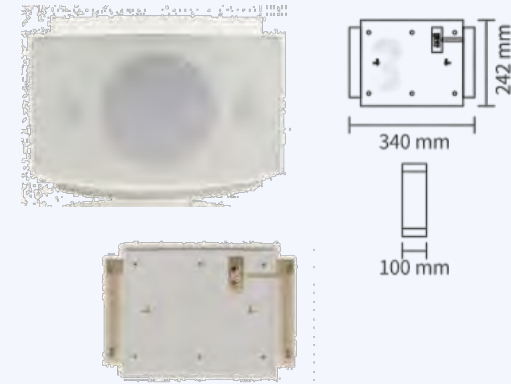

Wall mounted speaker
KD-720

SPECIFICATION		
Model No.	KD-717-5"	KD-717-6.5"
Rated Power	20W~30w	30W~40W
Constant voltage input	70v-100v	
S.P.L	90dB	
Frequency Range	90-16000Hz	
Speaker	φ5+3"tweeter	φ6.5" + 3"tweeter
External Size	244x185x163mm	298x218x190mm

SPECIFICATION	
Rated Power	20w
Constant voltage input	70v-100v
S.P.L	90dB
Frequency Range	90-16000Hz
Speaker	φ6.5" + 2x3"tweeter
External Size	340x242x100mm

Public Address Audio System—Wall Mounted Speaker Series



**Wall mounted speaker for conference
KD-722**

SPECIFICATION	
Rated Power	100w
Constant voltage input	70v-100v
S.P.L	90dB
Frequency Range	90-16000Hz
Speaker	φ5" H
External Size	360x260x300mm



**Wall mounted speaker for conference
KD-723-6.5" (W)
KD-724-6.5" (B)**

SPECIFICATION	
Rated Power	30w
Constant voltage input	70v-100v
S.P.L	90dB
Frequency Range	90-16000Hz
Speaker	φ5.5" H
External Size	80x80x270mm

Public Address Audio System——Wall Mounted Speaker Series

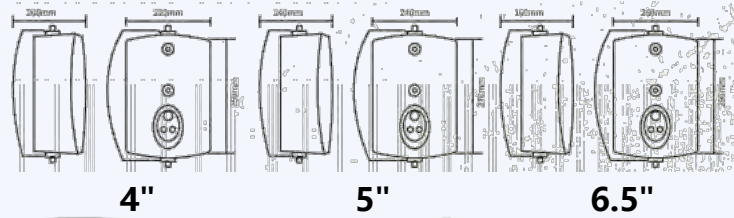

B&W

Wall mounted speaker for conference
KD-725
4"/-5"/-6.5"

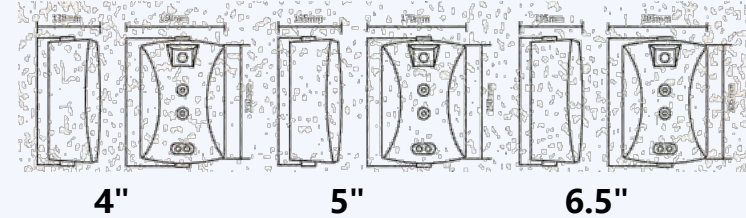

Wall mounted speaker for conference
KD-727 4"/-5"/-6.5"

SPECIFICATION			
Model No.	KD-725-4"	KD-725-5"	KD-725-6.5"
Rated Power	15W~20W	20W~30w	30W~40W
Constant voltage input	70v-100v		
S.P.L	90dB		
Frequency Range	90-16000Hz		
Speaker	φ4"+3"tweeter	φ5"+3"tweeter	φ6.5"+3"tweeter
External Size	220x250x200mm	240x270x140mm	260x290x160mm

SPECIFICATION			
Model No.	KD-727-4"	KD-727-5"	KD-727-6.5"
Rated Power	15W~20W	20W~30w	30W~40W
Constant voltage input	70v-100v		
S.P.L	90dB		
Frequency Range	90-16000Hz		
Speaker	φ4"+3"tweeter	φ5"+3"tweeter	φ6.5"+3"tweeter
External Size	150x210x130mm	170x250x155mm	205x305x195mm

Public Address Audio System——Wall Mounted Speaker Series

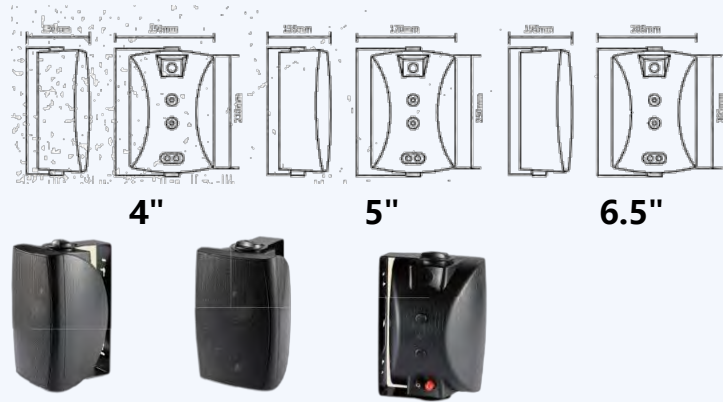

**Wall mounted speaker for conference
KD-728 4"/-5"/-6.5"**

SPECIFICATION			
Rated Power	KD-728-4"	KD-728-5"	KD-728-6.5"
Constant voltage input	15W~20W	20W~30w	30W~40W
S.P.L	70v-100v		
Frequency Range	90dB		
Speaker	90-16000Hz		
External Size	φ4"+3"tweeter	φ5"+3"tweeter	φ6.5"+3"tweeter
Rated Power	150x210x130mm	170x250x155mm	205x305x195mm

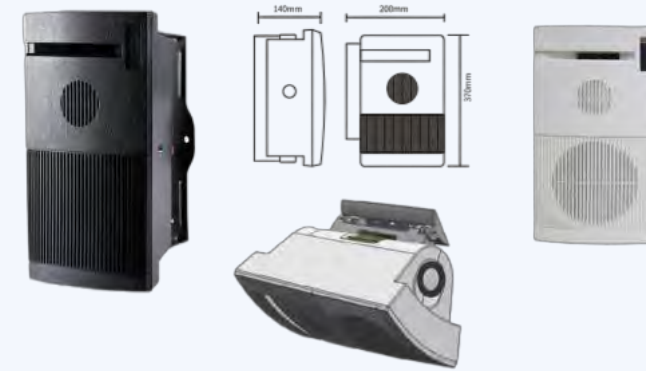

**Projector wall mounted speaker
KD-730 (B&W)**

SPECIFICATION	
Rated Power	20w
Constant voltage input	70v-100v
S.P.L	90dB
Frequency Range	90-16000Hz
Speaker	φ5.5"+3"tweeter
External Size	370×200x140mm

Public Address Audio System—Wall Mounted Speaker Series

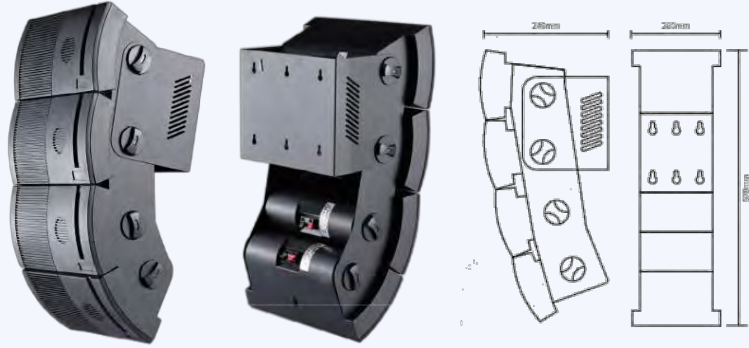

**Projector LA wall mounted speaker
(Constant voltage)
KD-4x730 (B&W)**

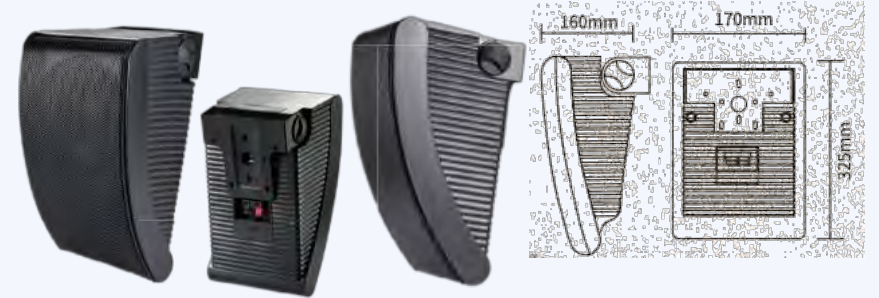

**Wall mounted speaker
KD-517**

SPECIFICATION	
Rated Power	80w
Constant voltage input	70v-100v
S.P.L	90dB
Frequency Range	90-16000Hz
Speaker	φ5.5"x4+3" tweeterx4
External Size	570x280x240mm

SPECIFICATION	
Rated Power	20~30w
Constant voltage input	70v-100v
S.P.L	90dB
Frequency Range	90-16000Hz
Speaker	φ5.5"+3" tweeter
External Size	325x170x160mm

Public Address Audio System—Wall Mounted Speaker Series

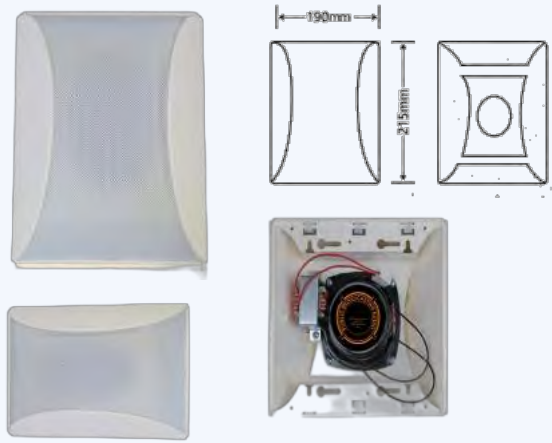

**Wall mounted speaker
KD-733**

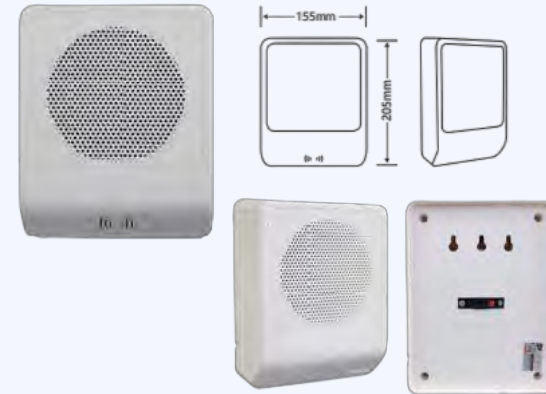

**Wall mounted speaker
KD-734**

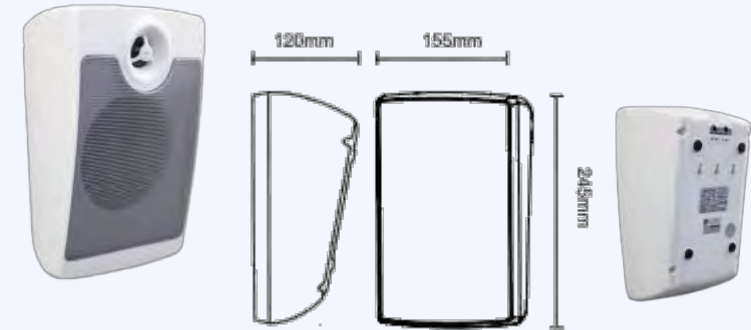

**Wall mounted speaker
KD-735**

SPECIFICATION	
Rated Power	10W~20w
Constant voltage input	70v-100v
S.P.L	90dB
Frequency Range	90-16000Hz
Speaker	φ4"
External Size	215×190×80mm

SPECIFICATION	
Rated Power	10W~15W
Constant voltage input	70v-100v
S.P.L	90dB
Frequency Range	90-16000Hz
Speaker	φ5"+3"tweeter
External Size	155x205x60mm

SPECIFICATION	
Rated Power	10w
Constant voltage input	70v-100v
S.P.L	90dB
Frequency Range	90-16000Hz
Speaker	φ6.5"+3"tweeter
External Size	245x155x120mm

Public Address Audio System—Wall Mounted Speaker Series



**Double-Sided Wall Mounted Speaker
KD-736**

SPECIFICATION	
Rated Power	2*10w
Constant voltage input	70v-100v
S.P.L	90dB
Frequency Range	90-16000Hz
Speaker	φ4"x2
External Size	140x310x120mm

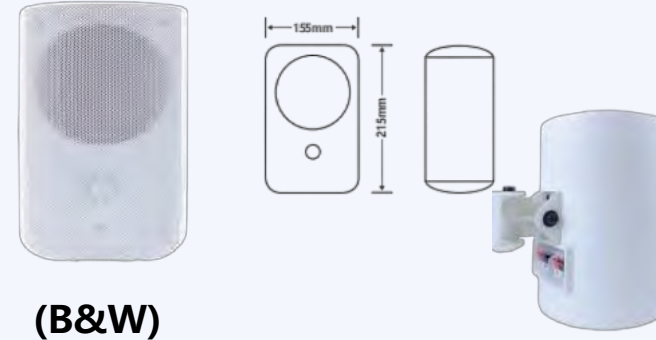

**(B&W)
Cylinder wall mounted speaker for conference
KD-737
(180° rotatable body, Constant voltage&Constant resistance adjustable)**

SPECIFICATION	
Rated Power	30w
Constant voltage input	70v-100v
S.P.L	90dB
Frequency Range	90-16000Hz
Speaker	φ5"*1+2.5" tweeter
External Size	215x155x190mm

Public Address Audio System—Indoor&outdoor Active Speaker Series for webcam

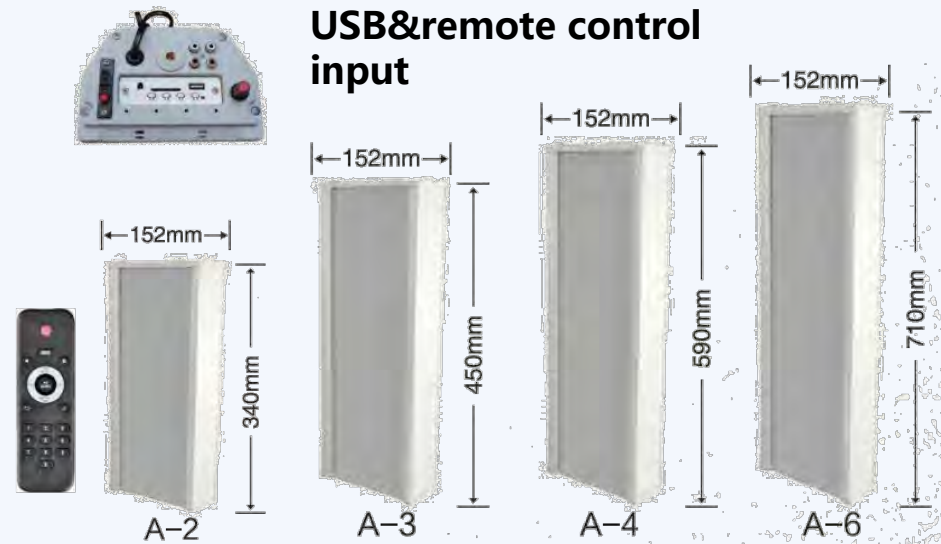

Outdoor Active Column Speaker (USB version)

Model No.	A-2	A-3	A-4	A-6
Rated Power	20W	30W	40W	60W
Input power supply	220V/12V			
Speaker	φ5 " x2	φ5 " x3	φ5 " x4	φ5 " x5
External size	152x340x100m m	152x450x100m m	152x590x100m m	152x710x100mm
Function	Audio input, Microphone input, Bluetooth input, USB input, Audio output, Volume control, the sub-speaker Power output			

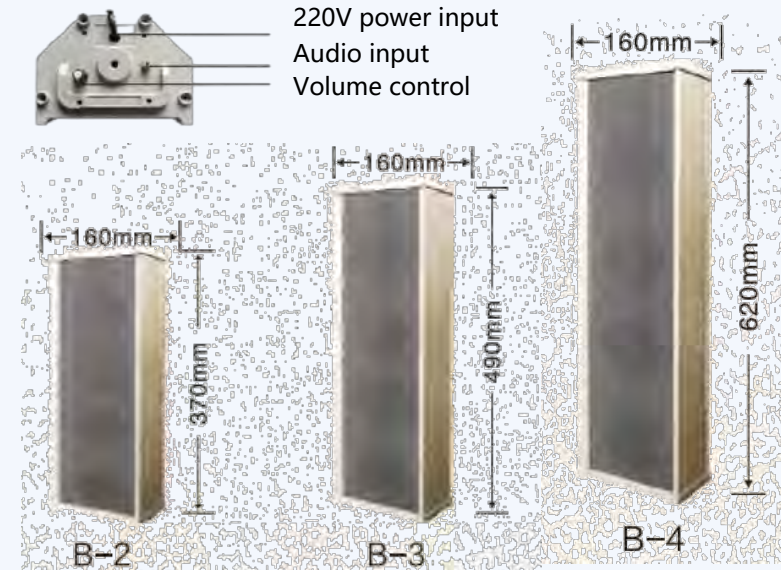

Outdoor Active Column Speaker (Audio input version)

Model No.	B-2	B-3	B-4
Rated Power	20W	30W	40W
Input power supply	220V/12V		
Speaker	φ5 " x2	φ5 " x3	φ5 " x4
External size	160x370x115m m	160x490x115m m	160x620x115m m
Function	Audio output, volume control		

Public Address Audio System—Indoor&outdoor Active Speaker Series for webcam

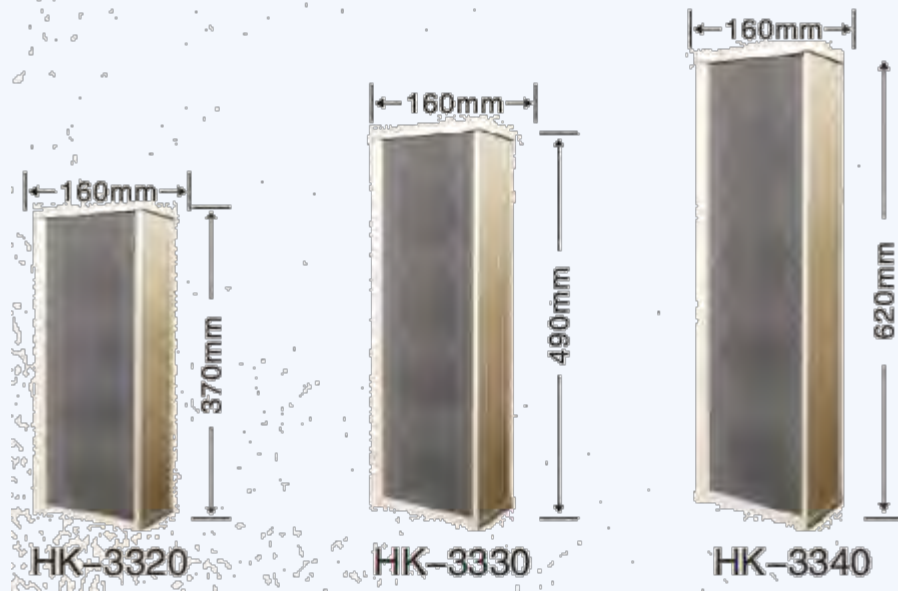

Hikvision Style outdoor column speaker

Model No.	HK-3320	HK-3330	HK-3340
Rated Power	20W	30W	40W
Input power supply	220V/12V		
Speaker	φ5 " x2	φ5 " x3	φ5 " x4
External size	160x370x115mm	160x490x115mm	160x620x115mm
Function	Audio output, volume control, 6 sets of audio arbitrary switching, Short-circuit triggered starting, USB input		

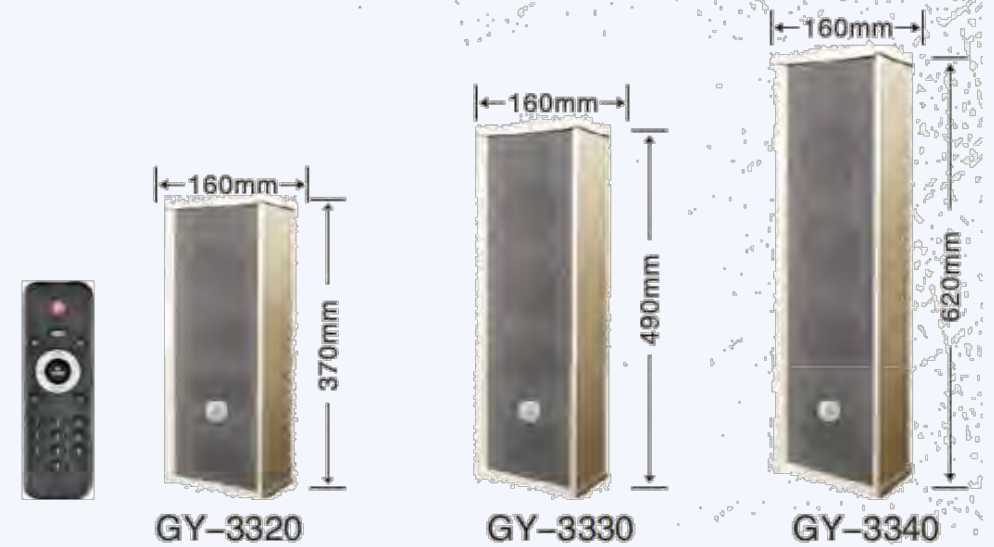

Outdoor column speaker (Bluetooth audio input)

Model No.	GY-3320	GY-3330	GY-3340
Rated Power	20W	30W	40W
Input power supply	220V/12V		
Speaker	φ5 " x2	φ5 " x3	φ5 " x4
External size	160x370x115mm	160x490x115mm	160x620x115mm
Function	Mobile Bluetooth audio storage, remote control&Bluetooth audio switch, memory recording, audio changes, sensor triggers and play		

Public Address Audio System—Indoor&outdoor Active Speaker Series for webcam

ECO Version

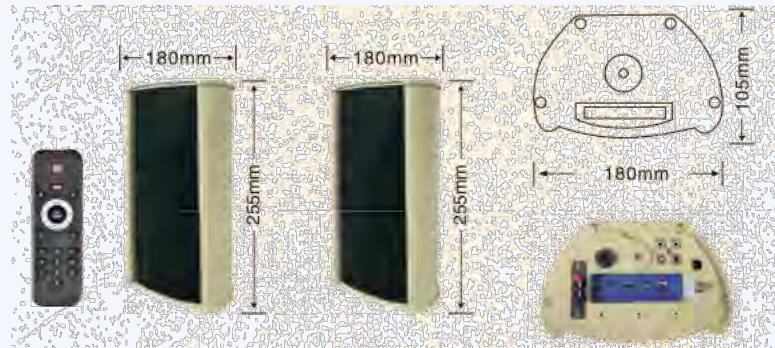

**Active Column pair Speaker (USB version)
A-1(master speaker + sub-speaker)**

Model No.	A-1
Rated Power	2x20W
Input power supply	220V/12V
Speaker	(5 " x2)+(5 " x2)
External size	370x180x105mm
Function	Audio input, Microphone input, Bluetooth input, USB input, Audio output, Volume control, the sub-speaker Power output

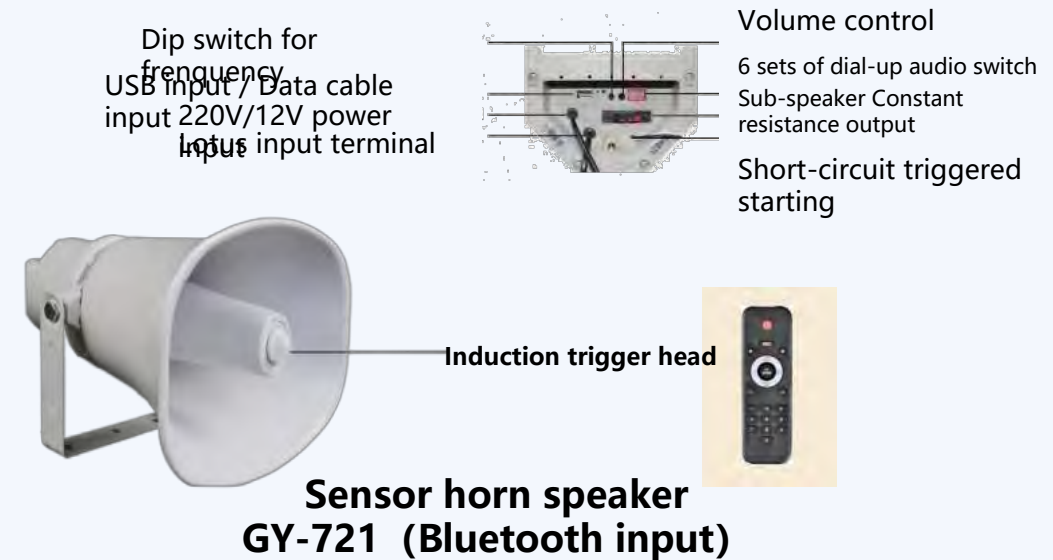

**Sensor horn speaker
GY-721 (Bluetooth input)**

SPECIFICATION	
Rated Power	30w
Constant voltage input	220V/12V
S.P.L	90dB
Frequency Range	90-16000Hz
Speaker	φ5 "tweeter
External Size	205x285x280mm

Public Address Audio System—Indoor&outdoor Active Speaker Series



SPECIFICATION	
Rated Power	20~30w
Constant voltage input	220V/12v
Speaker	φ5"
External size	260x225x105mm
Function	Bluetooth input/Audio Input/Volume control independent

SPECIFICATION	
Rated Power	2*20w
Constant voltage input	220V/12v
Speaker	φ5.5"
External size	168mm
Function	Bluetooth input

SPECIFICATION	
Rated Power	30w
Constant voltage input	220V/12v
Speaker	φ5" tweeter
External size	205x285x280mm
Function	Bluetooth input/Audio Input/Volume control independent

Public Address Audio System—Indoor&outdoor Active Speaker Series



SPECIFICATION

Rated Power	50w
Constant voltage input	220V/12v
Speaker	φ5.5"+3"tweeterx2
External size	366x230×272mm

SPECIFICATION

Rated Power	6w
Constant voltage input	220V/12v
Speaker	φ5"
External size	158x187x80mm

SPECIFICATION

Rated Power	20~30w
Constant voltage input	220V/12v
Speaker	φ5"+3"tweeter
External size	244x185x168mm

Public Address Audio System—Indoor&outdoor Active Speaker Series



**Active wood pair speaker
MP3-506**



**Active wood pair speaker (2.4G Version)
MP3-506-2.4G**



**Active ceiling speaker
(1 drag 4 magic box wired version)
R-808**

SPECIFICATION

Rated Power	2*30w
Constant voltage input	220V/12v
Speaker	φ6.5"+3"tweeter
External size	350x225x160mm
Function	Bluetooth input/Audio input/Volume control

SPECIFICATION

Rated Power	2*30w
Constant voltage input	220V/12v
Speaker	φ6.5"+3"tweeter
External size	350x225x160mm
Function	Bluetooth input/Audio input/Volume control (remote control)

SPECIFICATION

Rated Power	4x20W
Constant voltage input	220V/12v
Speaker	φ5.5" coaxial tweeter
External size	168mm
Function	Bluetooth input/Audio input/Volume control

Public Address Audio System—Indoor&outdoor Active Speaker Series

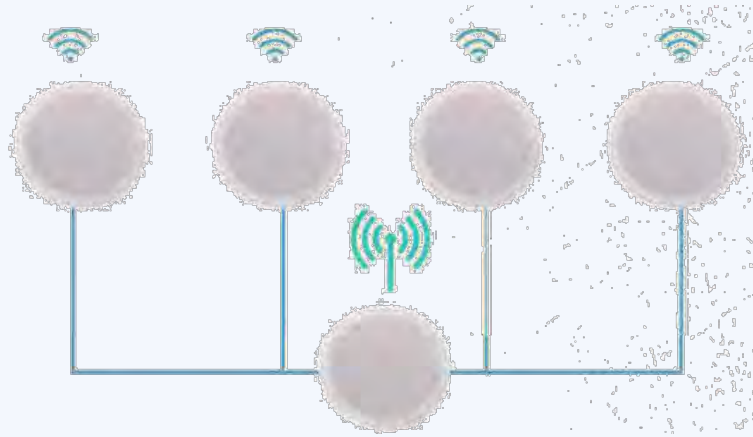

**Active ceiling speaker
V-1**

SPECIFICATION

Rated Power	20W×N pcs
Constant voltage input	220V/12v
Speaker	φ6.5"
External size	φ165mm
Function	Master speaker Bluetooth input/Sub-speaker wireless reception/Master&Sub speaker receiving distance radius ≤50m

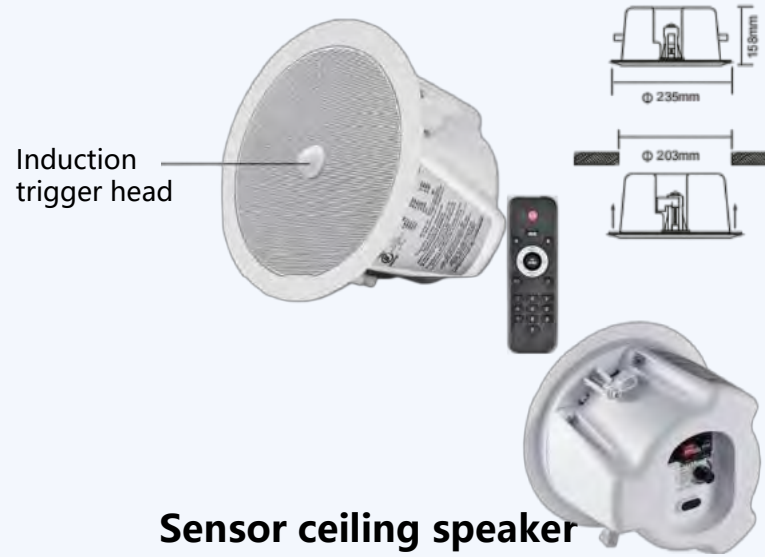

**Sensor ceiling speaker
GY-822 (Bluetooth input)**

SPECIFICATION

Rated Power	30W~40W
Constant voltage input	220V/12v
Speaker	φ6.5 " x1(coaxial tweeter)
Hole Size	φ203mm
External size	235x158mm



**Sensor wall mounted
speaker**

SPECIFICATION

Rated Power	10~15W
Constant voltage input	220V/12v
Speaker	φ5.5 " +3 "tweeter
External size	200x170x80mm

Public Address Audio System—Column Speaker Series

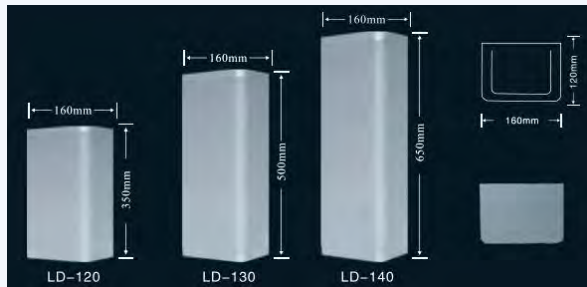

Series 1 (silver gray box, wood material)

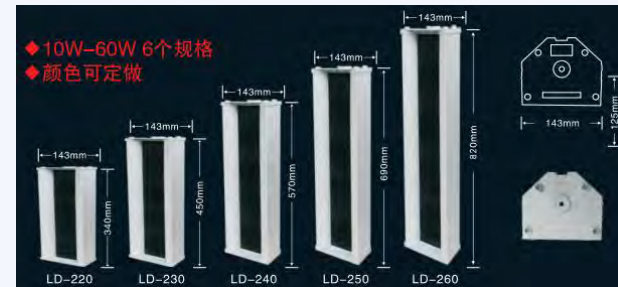

Series 2 (Ore white box)

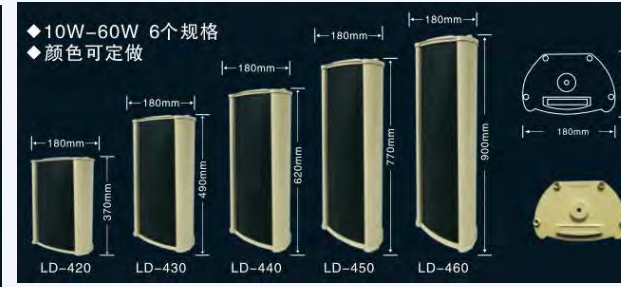

Series 4 (Champagne box)

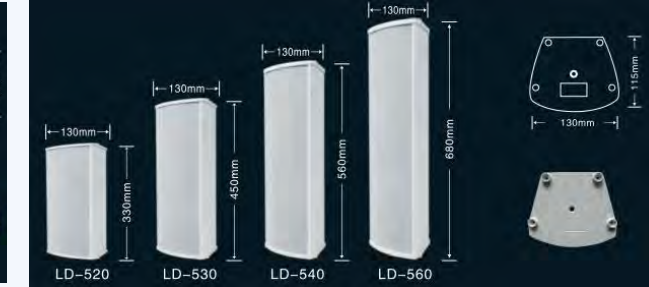

Series 5 (Opalescent box)

Model No.	LD-120	LD-130	LD-140	LD-210	LD-220	LD-230	LD-240	LD-250	LD-260	LD-410	LD-420	LD-430	LD-440	LD-450	LD-460	LD-520	LD-530	LD-540	LD-560
Rated Power	20w	30w	40w	10w	20w	30w	40w	50w	60w	10w	20w	30w	40w	50w	60w	20w	30w	40w	60w
Input	70V~100v																		
S.P.L	90dB																		
Frequency Range	90-18000Hz																		
Speaker	φ4									φ5						φ4			
Size	160×350mm	160×500mm	160×650mm	143×290mm	143×340mm	143×450mm	143×570mm	143×690mm	143×820mm	180×290mm	180×370mm	180×490mm	180×620mm	180×770mm	180×900mm	130×330mm	130×450mm	130×560mm	130×680mm
Function	These column speakers are with Full frequency waterproof horn, clear and bright sound, with high S.P.L, beautiful appearance, durable, easy to install. The voice and music have the amplification characteristics of restoring reality. Professional damp-proof, dust-proof design, suitable for supermarkets, station halls, stadiums, factory workshops and other public places																		

Public Address Audio System——Column Speaker Series

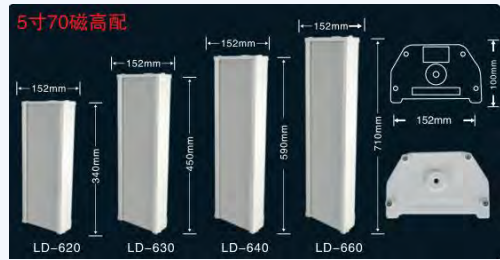

Series 6 (milk white)

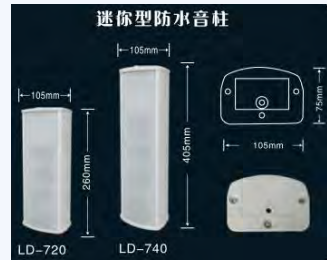

Series 7 (milk white)

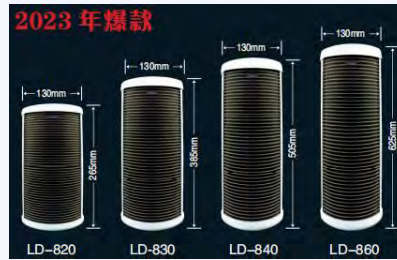

Series 8 (milk white)

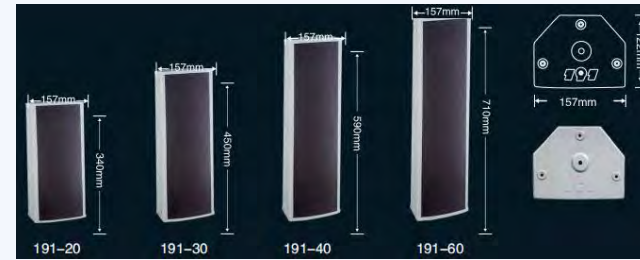

Series 191 (Space white body+ Black web)

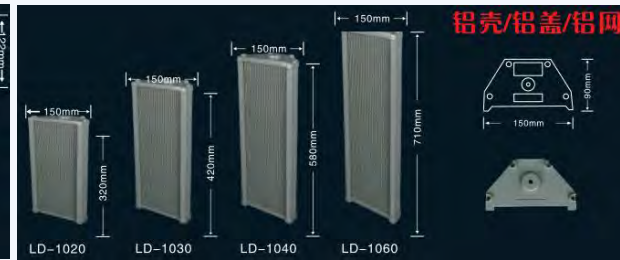

Series 10 (space grey)

Model No.	LD-620	LD-630	LD-640	LD-660	LD-720	LD-740	LD-820	LD-830	LD-840	LD-860	191-20	191-30	191-40	191-60	LD-1020	LD-1030	LD-1040	LD-1060
Rated Power	20w	30w	40w	60w	20w	40w	20w	30w	40w	60w	20w	30w	40w	60w	20w	30w	40w	60w
Input	70V~100v																	
S.P.L	90dB																	
Frequency Range	200HZ-10KHz																	
Speaker	φ5 *2	φ5 *3	φ5 *4	φ5 *5	φ3 *2	φ3 *3	φ4 x1+2.5 tweeter	φ4 x2+2.5 tweeter	φ4 x4+2.5 tweeter	φ4 x5+2.5 tweeter	φ4 ×2	φ4 ×3	φ4 ×4	φ4 ×5	φ4 ×2	φ4 ×3	φ4 ×4	φ4 ×5
Size	152x340mm	152x450mm	152x590mm	152x710mm	105x260mm	105x405mm	265x130mm	385x130mm	505x130mm	625x130mm	157x340mm	157x450mm	157x590mm	157x710mm	150x320mm	150x420mm	150x580mm	150x710mm
Function	These column speakers are with Full frequency waterproof horn, clear and bright sound, with high S.P.L, beautiful appearance, durable, easy to install. The voice and music have the amplification characteristics of restoring reality. Professional damp-proof, dust-proof design, suitable for supermarkets, station halls, stadiums, factory workshops and other public places																	

Public Address Audio System—Column Speaker Series

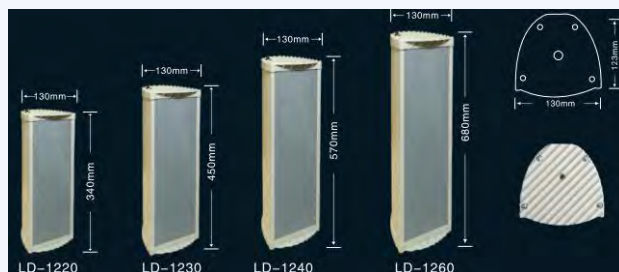

Series 12 (Matte champagne)

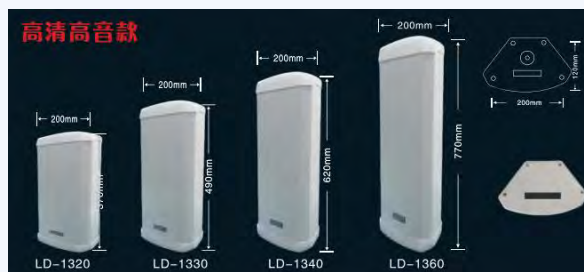

Series 13 (Bright White)

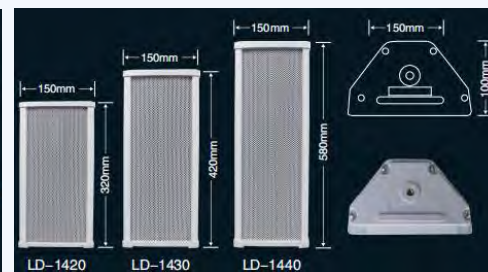

Series 14 (Bright White)



Series 15 (Bright White)



Series 16 (Bright White+Black Web)

Model No.	LD-1220	LD-1230	LD-1240	LD-1260	LD-1320	LD-1330	LD-1340	LD-1360	LD-1420	LD-1430	LD-1440	LD-1520	LD-1540	LD-1620	LD-1630	LD-1640	LD-1660
Rated Power	20w	30w	40w	60w	20w	30w	40w	60w	20w	30w	40w	20w	40w	20w	30w	40w	60w
Constant voltage input	70V~100v																
S.P.L	90dB																
Speaker	φ4"				φ5"				φ4"x1+t weeter	φ4"x2+t weeter	φ4"x3+t weeter	φ3"x2+t weeter	φ3"x2+t weeterx 2	φ4"x1+t weeter	φ4"x2+t weeter	φ4"x3+t weeter	φ4"x4+t weeter
Size	130x340mm	130x450mm	130x570mm	130x680mm	200x370mm	200x490mm	200x620mm	200x770mm	150x320mm	150x420mm	150x580mm	90x83x310mm	90x83x610mm	150x270mm	150x400mm	150x520mm	150x650mm
Function	These column speakers are with Full frequency waterproof horn, clear and bright sound, with high S.P.L, beautiful appearance, durable, easy to install. The voice and music have the amplification characteristics of restoring reality. Professional damp-proof, dust-proof design, suitable for supermarkets, station halls, stadiums, factory workshops and other public places																

Public Address Audio System—Column Speaker Series

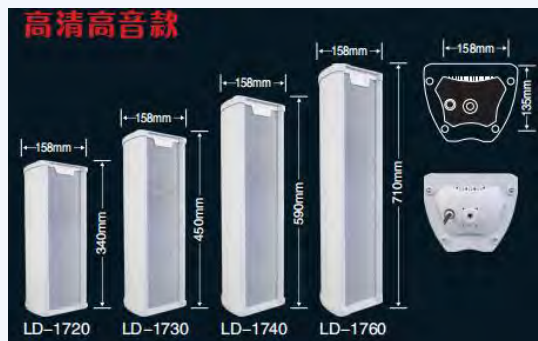

Series 17 (bright White)

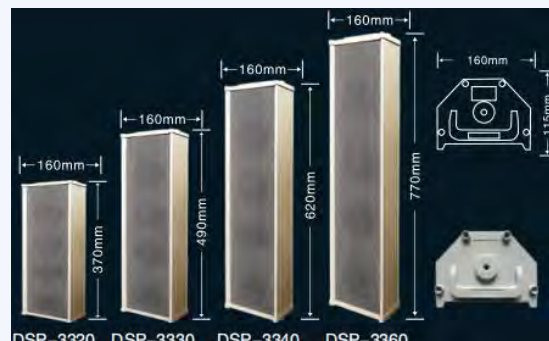

Series 33 (Matte champagne)

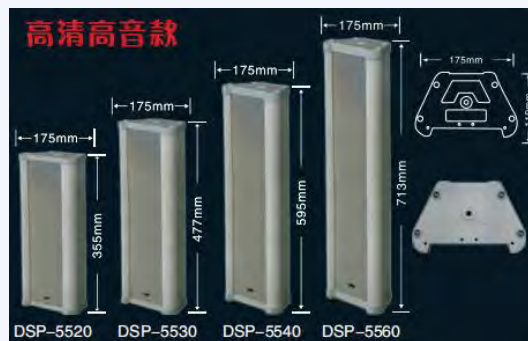

Series 55 (bright grey)

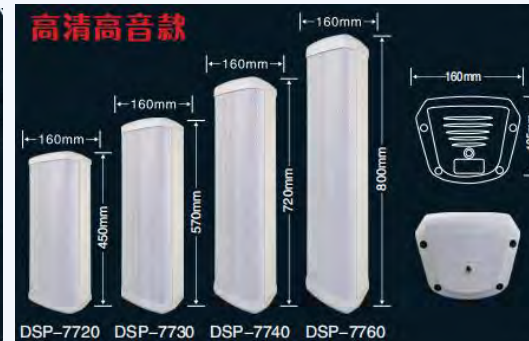

Series 77 (bright White)

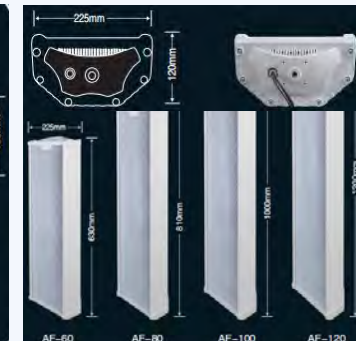

AF widen series (bright White)
Aluminum alloy housing

Model No.	LD-1720	LD-1730	LD-1740	LD-1760	DSP-3320	DSP-3330	DSP-3340	DSP-3360	DSP-5520	DSP-5530	DSP-5540	DSP-5560	DSP-7720	DSP-7730	DSP-7740	DSP-7760	AF-60	AF-80	AF-100	AF-120
Rated Power	20w	30w	40w	60w	20w	30w	40w	60w	20w	30w	40w	60w	25w	35w	45w	65w	60w	80w	100w	120w
Input	70V~100v																			
S.P.L	90dB																			
Speaker	φ4"x2+ tweeter	φ4"x3+ tweeter	φ4"x4+ tweeter	φ4"x5+ tweeter	φ5"×2	φ5"×3	φ5"×4	φ5"×5	4"x2+t tweeter	4"x3+t tweeter	4"x4+t tweeter	4"x5+t tweeter	4"x2+t tweeter	4"x3+t tweeter	4"x4+t tweeter	4"x5+t tweeter	6.5"x2+ tweeter	6.5"x3+ tweeter	6.5"x4+ tweeter	6.5"x5+ tweeter
Size (mm)	158x340	158x450	158x590	158x710	160X370	160X490	160X620	160X770	175X355	175X477	175X595	130X713	160x450	160x570	160x720	160x800	225X630	225X810	225x1000	225x1200

Function These column speakers are with Full frequency waterproof horn, clear and bright sound, with high S.P.L, beautiful appearance, durable, easy to install. The voice and music have the amplification characteristics of restoring reality. Professional damp-proof, dust-proof design, suitable for supermarkets, station halls, stadiums, factory workshops and other public places

Public Address Audio System—Column Speaker Series

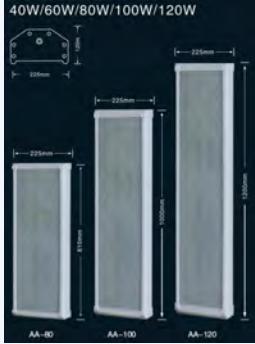

AA Series widen(White)



BB series widen(White)



DD series widen(Matte champagne)

Tweeter

Model No.	AA-40	AA-60	AA-80	AA-100	AA-120	BB-40	BB-60	BB-80	BB-100	DD-40	DD-60	DD-80	DD-100	DD-120
Rated Power	40w	60w	80w	100w	120w	40w	60w	80w	100w	40w	60w	80w	100w	120w
Input	70V~100v													
S.P.L	90dB													
Speaker	φ6.5"*2	φ6.5"*3	φ6.5"*4	φ6.5"*5	φ6.5"*6	φ6.5"*2	φ6.5"*3	φ6.5"*4	φ6.5"*5	φ4"x2+t weeter	φ4"x3+t weeter	φ4"x4+t weeter	φ4"x5+t weeter	φ4"x6+t weeter
External Size(mm)	225x570 x120	225x630 x120	225x810 x120	225x1000 x120	225x1200 x120	200x450 x155	200x530 x155	200x810 x155	200x1000 x155	200x507 x142	200x674 x142	200x820 x142	200x1005 x142	200x1175 x142
Function	These column speakers are with Full frequency waterproof horn, clear and bright sound, with high S.P.L, beautiful appearance, durable, easy to install. The voice and music have the amplification characteristics of restoring reality. Professional damp-proof, dust-proof design, suitable for supermarkets, station halls, stadiums, factory workshops and other public places													

Public Address Audio System—Column Speaker Series

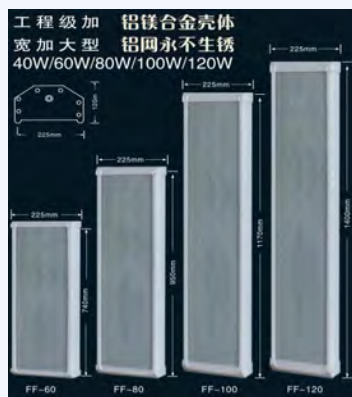

**FF series wideband
(White)**



**797 Series (Pro)
wideband(Bright grey)**

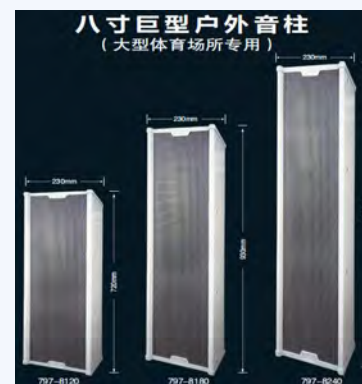

Special for large sports place

797-8" Series (White)

Model No.	FF-40	FF-60	FF-80	FF-100	FF-120	797-80	797-100	797-120	797-140	797-8120	797-8180	797-8240
Rated Power	40w	60w	80w	100w	120w	80w	100w	120w	140w	120w	180w	240w
Input	70V~100v											
S.P.L	90dB											
Speaker	φ6.5"*2	φ6.5"*3	φ6.5"*4	φ6.5"*5	φ6.5"*6	φ(H)6.5"* 2+tweeter	φ(H)6.5"* 3+tweeter	φ(H)6.5"* 4+tweeter	φ(H)6.5"* 5+tweeter	φ(H)8"*2 +tweeter	φ(H)8"*3 +tweeter	φ(H)8"*4 +tweeter
External Size(mm)	225x520x 120	225x740x 120	225x950x 120	225x1170 x120	225x1400 x120	230x720x 190	230x930x 190	230x1150 x190	230x1380 x190	230x720x 190	230x930x 190	230x1150 x190

Function These column speakers are with Full frequency waterproof horn, clear and bright sound, with high S.P.L, beautiful appearance, durable, easy to install. The voice and music have the amplification characteristics of restoring reality. Professional damp-proof, dust-proof design, suitable for supermarkets, station halls, stadiums, factory workshops and other public places

Public Address Audio System—Full frequency Column Speaker Series

(Constant voltage/Constant resistance adjustable)



HY wood series (Paint black)

HY metal series (Bright White)

HY plastic series (Bright Black)

Model No.	HY-2040	HY-3020	HY-3040	HY-4020	HY-4040
Rated Power	110V/40W-60W 8Ω/120w	110V/20W-40W 8Ω/60w	110V/40W-60W 8Ω/120w	110V/20W-40W 8Ω/60w	110V/40W-60W 8Ω/120w
Constant voltage/Constant resistance Input	110V/8Ω				
S.P.L	90dB				
Speaker	φ5.5"x4Coaxial	φ5.5"x2Coaxial	φ5.5"x4Coaxial	φ5.5"x2Coaxial	φ5.5"x4Coaxial
External Size(mm)	135X170X675	330X115X150	655X115X150	330X115X150	655X115X150

Function

These column speakers are with Full frequency waterproof horn, clear and bright sound, with high S.P.L, beautiful appearance, durable, easy to install. The voice and music have the amplification characteristics of restoring reality. Professional damp-proof, dust-proof design, suitable for supermarkets, station halls, stadiums, factory workshops and other public places

Public Address Audio System——Hanging Spherical Speaker Series

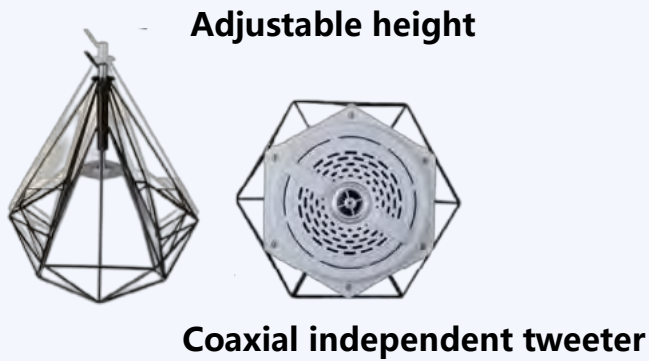

**Iron Hanging Spherical Speaker
KD-900**



Hanging Spherical Speaker
KD-901 (W) KD-901B(Coaxial W)
HS-901 (B) HS-901B(Coaxial B)



**Hanging Spherical Speaker
(1m cable available)**
KD-903(W) KD-906(Coaxial B)
KD-904 (B) KD-907(Coaxial W)

SPECIFICATION

Rated Power	20w
Constant voltage input	70V-110V
Speaker	φ5.5"Coaxial
External size	280x320x900mm

SPECIFICATION

Rated Power	20w
Constant voltage input	70V-110V
Speaker	φ5.5"Regular/coaxial tweeter
External size	φ255x460xRod length 220mm

SPECIFICATION

Rated Power	20w
Constant voltage input	70V-110V
Speaker	φ5.5"Regular/coaxial tweeter
External size	φ180x655mm

Public Address Audio System——Hanging Spherical Speaker Series



Hanging Spherical Speaker
KD-910 (W) HS-910(B)

SPECIFICATION	
Rated Power	30w~40w
Constant voltage input	70V-110V
Speaker	φ5.5" Coaxial
External size	φ218×265×655mm



Hanging Spherical Speaker
KD-901 (W) KD-901B(Coaxial W)
HS-901(B) HS-901B(Coaxial B)

SPECIFICATION	
Rated Power	20w
Constant voltage input	70V-110V
Speaker	φ5"
External size	φ167×655mm

Public Address Audio System——Hanging Spherical Speaker Series

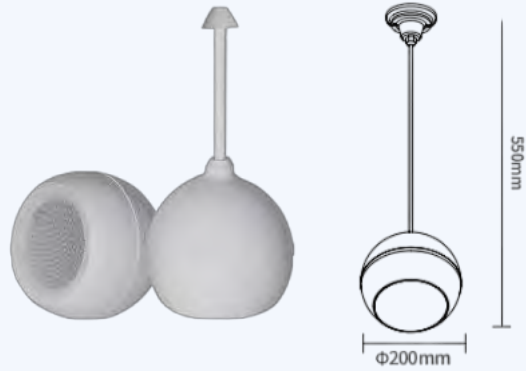

**Hanging Spherical Speaker
(1m cable available)**

KD-903(W) KD-906(Coaxial B)
KD-904(B) KD-907(Coaxial W)



**Hanging Spherical Speaker
KD-738 (Rod length: 330mm)**

SPECIFICATION

Rated Power	20w
Constant voltage input	70V-110V
Speaker	φ5"
External size	φ550*200mm

SPECIFICATION

Rated Power	20~30w
Constant voltage input	70v-100v
S.P.L	90dB
Frequency Range	90-16000Hz
Mounting Hole Hole for mounting	φ5.5"x1
External Size	210×210x520mm

Public Address Audio System——Garden Speaker Series



320×250×480mm

CPY-01



320×250×480mm

CPY-02



320×250×480mm

CPY-03



340×340×340mm

CPY-19



280×330×450mm

CPY-21



400×360×435mm

CPY-23



320×250×480mm

CPY-01



390×340×340mm

CPY-34



230×280×420mm

CPY-90



340×315×500mm

CPY-91



280×330×450mm

CPY-21



400×360×435mm

CPY-23



ABS Material
Double speakers

320×250×480mm

CPY-01



ABS Material
Double speakers

320×250×480mm

CPY-02



ABS Material
Double speakers

320×250×480mm

CPY-03



485×210×590mm

CPY-15



270×270×305mm

CPY-20



200×750mm

CPY-61

Public Address Audio System—Garden Speaker Series



Tweeter

330×280×340mm

CPY-25



270×320×320mm

CPY-26



Tweeter

330×280×340mm

CPY-27(Grey)

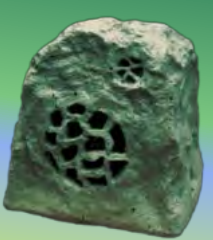

Tweeter

330×280×340mm

CPY-27(Green)



320×270×270mm

CPY-28



280×220×270mm

CPY-29

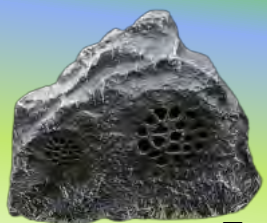

Tweeter

460×330×320mm

CPY-30(Grey)

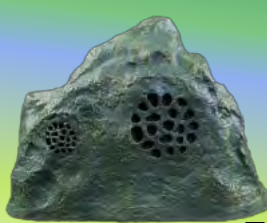

Tweeter

460×330×320mm

CPY-30(Green)



390×280×500mm

CPY-31

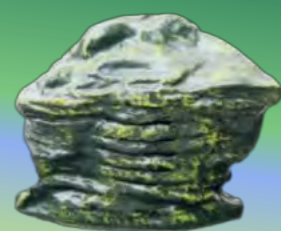

420×320×325mm

CPY-33



380×240×270mm

CPY-37

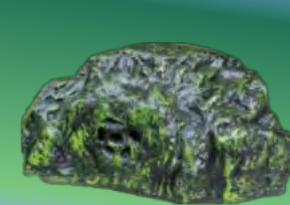

530×280×280mm

CPY-39

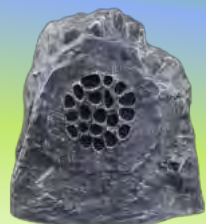

300×285×290mm

CPY-41(Grey)



300×285×290mm

CPY-41(Green)

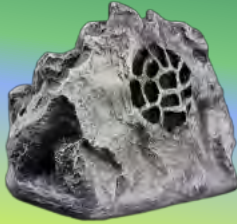

285×264×348mm

CPY-45



280×240×240mm

CPY-71

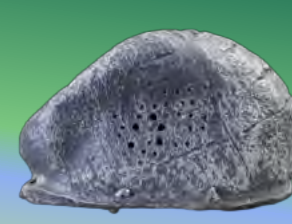

280×140×160mm

CPY-74



225×225×255mm

CPY-75(Grey)

Public Address Audio System——Garden Speaker Series



225×225×255mm

CPY-75 (Green)



225×225×255mm

CPY-75 (Yellow)



225×225×255mm

CPY-75 (Brown)



335×275×510mm

CPY-133



450×270×270mm

CPY-165 (Yellow)



450×270×270mm

CPY-165 (Grey)



250×340mm

CPY-67



390×365×735mm

CPY-82



265×265×725mm

CPY-85



300×300×360mm

CPY-93



370×375×280mm

CPY-94



290×290×430mm

CPY-100

Public Address Audio System—IP network broadcast system equipment



**IP network broadcast
equipment**

ZH-IP201

Product description

IP network broadcast server is the core of network audio broadcast system, which monitors the working status of all terminals and external devices in the whole network broadcast system in real time, and responds to all kinds of service requests of all terminals in real time.

- Industrial server, high stability, high reliability.
- Industrial-grade low-power processor, equipped with solid state drive, faster data reading and storage, stronger anti-fall and anti-shock performance.
- The system provides a powerful channel broadcast management Function, supporting multiple sets of channel broadcast online simultaneous broadcast, each channel broadcast can support timed task management mode or manual control management mode.
- The system has multiple sets of scheduled task management schemes, supporting multi-mode operation of scheduled tasks, scheduled tasks can be controlled by week cycle, or can be executed by 24 hours a day scheduled tasks, through flexible scheduled task configuration, fully suitable for a variety of complex applications.

Public Address Audio System—IP network broadcast system equipment

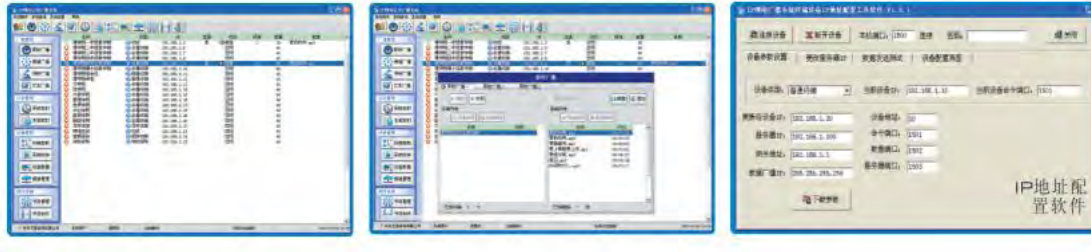

IP digital network broadcasting software

ZH-IP202

Product description

System management software is an important part of IP network broadcasting system, it can be installed in any computer in the network, used for the entire IP network broadcasting system equipment configuration, channel configuration, task configuration, program library management, user management, permission management, terminal equipment status query and control operation of terminal equipment.

- The system terminal equipment status real-time monitoring query management function;
- Configuration management Function in terminals and peripherals;
- Channel song configuration management function;
- It has the Function of editing and managing server scheduled tasks;
- Terminal SD program file download management function;
- Real-time broadcast control management function;
- Channel broadcast control management function;
- Equipment control management function;
- Have media resource program library management function.
- Server and device timing function;
- Program production and file upload and download management function;
- The system user and permission allocation management function;
- Directly access the standard TCP/IP protocol network, and use the existing network to achieve multi-network integration. The embedded system is used as the main architecture to avoid virus attacks on the broadcast host;
- When the server in the general control room is disconnected, the broadcast use of each sub-control room and partition will not be affected;
- Campus broadcast software is the core of the total campus audio broadcast system, which completes the permission management Function of the entire campus, provides data interface services for the acquisition and broadcasting of various audio broadcasts, and provides network broadcasting equipment in various regions with timed playback and real-time acquisition media services, and responds to the playback requests of each broadcast control equipment. After the audio program menu is arranged, it can be uploaded to the system service through the campus network, and the management personnel can log in to modify it through the broadcast management software;
- Automatically detect faulty network broadcast devices;
- Automatic control and manual operation platform with programming accurate to seconds
- Easy to operate, intuitive display. It can display the current working status of each network terminal in real time, and has man-machine dialogue function;

Public Address Audio System—IP network broadcast system equipment



**IP broadcast paging
microphone**

ZH-IP207

Product description

- With dual-port HUB (HUB), it can directly access the local area network (LAN), play network audio, and accept the access and control of servers and other IP network devices;
- Network fault self-diagnosis, network and service status display. The core equipment of network intercom can directly paging and two-way intercom to various types of terminal equipment;
- External gooseneck Microphone, built-in Speaker;
- Offline Function, can directly access the network to use, paging and intercom without server support, the use of extremely convenient and simple;
- Multi-party calls are supported during intercom;
- Paging and intercom permission control Function;
- Line input and output to transmit local audio signals to the network;
- With SD card, you can directly play the music program of SD card, you can convert the music of SD card into network data stream, and pass to other terminal devices.



**IP digital network broadcast power amplifier
terminal**

ZH-IP208

Product description

- 1 network signal input, 1 audio signal output.
- 2-way power control (220V), the maximum power is 1200W.
- Compatible with TCP/IP network protocol, to achieve cross-gateway device control and status real-time monitoring.
- High-grade aluminum panels with advanced polishing.

Public Address Audio System—IP network broadcast system equipment



**IP network audio converter
(ZH-IP220)**



**IP network fire access device
(ZH-IP211)**

Function description

- Standard chassis, 2U height; High-grade aluminum panel with advanced polishing;
- Adopt fixed static IP address, stable work;
- Adopt embedded PC technology and DSP audio processing technology;
- 1 RJ45 download address interface for different places of the network to modify the address;
- Transmission of multiple sets of audio program content through the network;
- Single device has 1 audio matrix switching function;
- 1 LINE/MIC signal input, 1 independent network TCP/IP coding function; Independent volume adjustment; High quality digital audio transmission, no noise, can be one-way call;
- Sound quality can reach CD level (audio file bit speed is 32-320kdps adaptive);

Product description

- 16 zones are automatically activated, which can be extended to 1024 zones, and up to 80 adjacent zones are automatically triggered.
- Fire alarm intelligent interface, support contact input and DC voltage input. Programmable setting of N+1, N+2, N+3, N+4 alarm rules.
- Built-in digital alarm player, to achieve a more user-friendly partition independent voice alarm function;
- RJ45 transmits alarm signals through the interface, easy to connect;

Public Address Audio System—IP network broadcast system equipment



Function description

- Built-in embedded network voice decoding module, into the network audio stream synchronous reception and decoding: using embedded PC technology and DSP audio processing technology design: using high-speed industrial ARM chip, start-up time reaches millisecond level; Improve the stability of equipment;
- TCP/IP high quality digital audio transmission, sound quality up to CD level bit speed 320kdps) using fixed static IP address, when the network changes the address will not be lost, stable work; The machine is equipped with P address reset switch, reset can restore factory Settings;
- 1 network,2 LINE inputs,2 MIC inputs; To realize local external sound source input and emergency broadcast input, each has an independent volume adjustment; 1 EMC input, priority network and other external signals, so that a variety of linked emergency alarm equipment diversification; EMC inputs have the highest priority, network alarm signals have priority over local MIC inputs, local MIC inputs have priority over AUX and network music, and local AUX and network music signals have no priority;
- Each MIC/LINE signal input has an independent digital volume adjustment.
- Full digital treble, bass and master volume adjustment, allowing the sound quality to be adjusted freely: the adjustment is clearer, flexible and accurate;

Specification

MD-60	60W
MD-120	120W
MD-180	180W
MD-250	250W
MD-350	350W
MD-500	500W
MD-650	650W
MD-800	800W
MD-1000	1000W
MD-1500	1500W

- Expansion terminals are reserved and can be configured with a DC24V power module. With a three-wire alarm strong cutting output interface, the host controls the corresponding control area alarm: no additional 24V strong cutting power supply, the number of audio control is not limited; Reserve one RS232 serial port for easy expansion;
- Automatic fault detection and LED prompt function, automatic detection system function and overload, high temperature, overvoltage protection; Pressure circuit processing effectively avoids audio output signal distortion;

Public Address Audio System—IP network broadcast system equipment



Wood material



**IP digital network speaker
(ZH-IP206)**

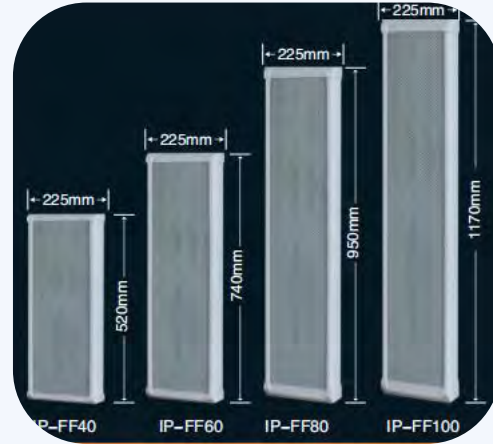

**IP network Column Speaker
(IP-FFF series)**

Specification

IP-FF40	40W
IP-FF60	60W
IP-FF80	80W
IP-FF100	100W

Function description

- Built-in embedded network speech decoding module, into the network audio stream synchronous reception and decoding: the use of embedded PC technology and DSP tone processing technology design: the use of high-speed industrial ARM chip, start-up time up to milliseconds; Improve the stability of equipment;
- TCPIP high quality digital audio transmission, sound quality up to CD level bit speed 320kdps)
- Using fixed static IP address, when the network changes the address will not be lost, stable work;
- The machine is equipped with a home address reset switch, reset can restore the factory setting 1 network,2 LINE input,2 MIC input: to achieve local external sound source input and emergency broadcast input. Each channel has an independent volume adjustment; 1 EMC input, priority network and other external signals, so that a variety of linked emergency alarm equipment diversification :EMC input has the highest priority, network alarm signal priority local MIC input, local M-just C input priority over AUX and network music, local AUX and network music signal no priority.
- Each MIC/LINE signal input has an independent digital volume adjustment.

Public Address Audio System—IP network broadcast system equipment

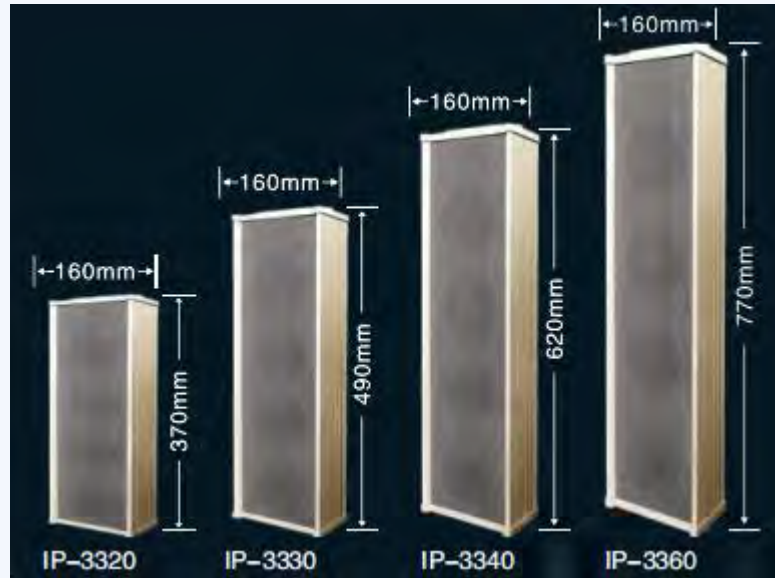

33 Series (Alumilum material)

IP network column speaker

Specification

IP-3320	20W
IP-3330	30W
IP-3340	40W
IP-3360	60W

Function description

- Built-in embedded network voice decoding module, into the network audio stream synchronous reception and decoding; using embedded PC technology and DSP audio processing technology design: using high-speed industrial ARM chip, start-up time reaches millisecond level; Improve the stability of equipment; TCPP High quality Jiao character sound frequency transmission, sound quality reaches CD level (bit speed 320kdps)
 - Fixed static IP address, when the network changes the address will not be lost, stable work;
- The machine is equipped with a P address reset switch, which can restore the factory setting. Each MIC/LINE signal input has an independent digital volume adjustment.
- Full digital treble, bass and main volume book, so that the sound quality is free to adjust: adjust the official and clear, flexible and accurate.
 - Automatic fault detection and LED prompt function, automatic detection system function and overload, high temperature overvoltage protection; The voltage line circuit tends to effectively transmit free audio output signal distortion

Public Address Audio System——4G wireless voice equipment system



4G wireless Voice Control Terminal
(SIM/network input)
EVA-F800
Functions&Features 

- | | |
|----------------------------------|--|
| Android mobile | APP remote playback |
| APP download interface | Automatically external power control |
| Mobile APP remote call | Automatically corrects the world clock |
| Mobile APP remote recording call | Automatic remote control |
| Mobile APP text to voice call | Unlimited distance instant broadcast |



4G Cloud microphone
(No distance limited)
EVA-F8004
Functions&Features 

- | | |
|----------------------------------|--|
| Android mobile | APP remote playback |
| APP download interface | Automatically external power control |
| Mobile APP remote call | Automatically corrects the world clock |
| Mobile APP remote recording call | Automatic remote control |
| Mobile APP text to voice call | Unlimited distance instant broadcast |



4G Wireless 4G village terminal
EVA-F800-H
Functions&Features 

- | | |
|-----------------------------------|--|
| Power: 2x50w | APP remote playback |
| Output: 2x8Ω | Automatically external power control |
| IP grade:XP6 | Automatically corrects the world clock |
| Receiving mode :SIM/network input | Automatic remote control |
| Android mobile | Unlimited distance instant broadcast |
| APP download interface | |
| Mobile APP remote call | |
| Mobile APP remote recording call | |
| Mobile APP text to voice call | |

Public Address Audio System—4G wireless voice equipment system



Wireless 4G voice wall mounted speaker
(SIM/network input)
EVA-F800-L

Functions&Features

Power:40W	Output 8Ω
Material: ABS	Receiving mode :SIM/ network
Android mobile input	APP remote playback
APP download interface	Automatically external power control
Mobile APP remote call	Automatically corrects the world clock
Mobile APP remote recording call	Automatic remote control
Mobile APP text to voice call	Unlimited distance instant broadcast

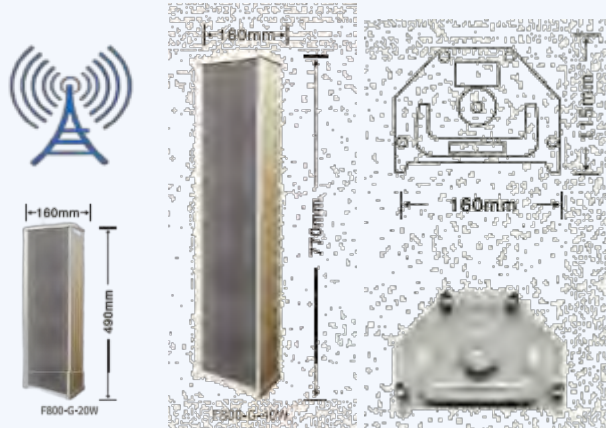

Wireless 4G voice outdoor Column Speaker
(SIM/network input)
EVA-F800-G-20W/-40W

Functions&Features

Power:20W/40W	Output 8Ω
Material:Magal	Receiving mode :SIM/ network
Android mobile input	APP remote playback
APP download interface	Automatically external power control
Mobile APP remote call	Automatically corrects the world clock
Mobile APP remote recording call	Automatic remote control
Mobile APP text to voice call	Unlimited distance instant broadcast



4G wireless tweeter speaker
YH-180-8"
YH-250-10"
YH-350-12"
YH-500-15"
Constant resistance speaker

Functions&Features

Power: 20W/40W	Output 8Ω
Material:Magal	Receiving mode :SIM/
Android mobile input	APP remote playback
APP download interface	Automatically external power control
Mobile APP remote call	Automatically corrects the world clock
Mobile APP remote recording call	Automatic remote control
Mobile APP text to voice call	Unlimited distance instant broadcast

Public Address Audio System—Wireless microphone Series



With prelude prompt tone

SM-88 CM-38

Conference gooseneck microphone

- ◆ Model No.: SM-88/CM-38
- ◆ Type of Adapter: Capacitive
- ◆ Frequency Range: 40Hz-16KHz
- ◆ Directivity: Cardioid
- ◆ Output impedance: 200Ω
- ◆ S.P.L: -42dB±2
- ◆ Power supply: DC3V
- ◆ Mic cable length: standard 500CM



V
band

OK-2600



U
band

OK-2600A

Wireless Microphone

1. Reception performance

Reception performance: Quartz crystal controls the locking frequency

Receiver S.P.L:60dbs(12dBu)

SNR:>100dB

Audio output level: CHA+ imbalance 0-0.5V/5KΩ

The CHA and CHB are unbalanced from 0 to 0.5V/5 Kω

Size:20(L)x 240(W)×45(H)mm

2. Transmitter performance

RF Power:30mW(Max)

Suppression :> Carrier 45dB

Antenna: Completely hidden

Microphone: moving coil type super heart type single directional

Battery: Standard 9V battery

Battery consumption: About 25mA

Battery life: more than 8 hours of continuous use

Size:52(D) x247(L)m/m

Weight: About 227gs

3. System indicators

Frequency range :VHF high band 220-270MHz

Frequency stability :0.005%

Modulation mode :FM

Maximum frequency offset: ±15KHZ

Audio response :40HZ-20KHZ

SNR:100dB

Dynamic range :100dB

Comprehensive distortion :≤0.5%

Operating range :50 m radius (when there is no obstacle)

Operating temperature :-10°C-50°C

Public Address Audio System—Volume Controller



Regular 5 levels volume controller (White)

YV-6-6W
YV-10-10W
YV-30-30W
YV-60-60W



5 levels volume controller (Space black)

HS-6-6W
HS-10-10W
HS-30-30W
HS60-60W

Knob



5 levels volume controller (Gold)

JS-6-6W
JS-10-10W
JS-30-30W
JS-60-60W

knob



Stepless Volume Controller

WJ-6-6W
WJ-10-10W
WJ-30-30W
WJ-60-60W

Stepless

PUBLIC ADDRESS SYSTEMS - USE CASES



Stadium application: Play live competition, music, advertising, etc



Airport application: Play flight information, safety tips, advertisements, etc

PUBLIC ADDRESS SYSTEMS - USE CASES



Shopping mall application: Play promotional information, music, advertisements, etc



Campus application: Playing campus announcements, music between classes, teaching, etc

PUBLIC ADDRESS SYSTEMS - USE CASES



Hospital application: Play medical information, emergency notifications, etc



Other public applications: music, radio notification, emergency evacuation, conference system, etc