



2024
Product
Brochure

REWARD AND AUDIT



Factory Audit

Walmart

ACCO

CVS

Office DEPOT®



MAJOR CUSTOMER





PRESS



**INJECTION
MOLDING MACHINE**



**WORKSHOP
WORK AS**



**OFFICE
ENVIRONMENT**

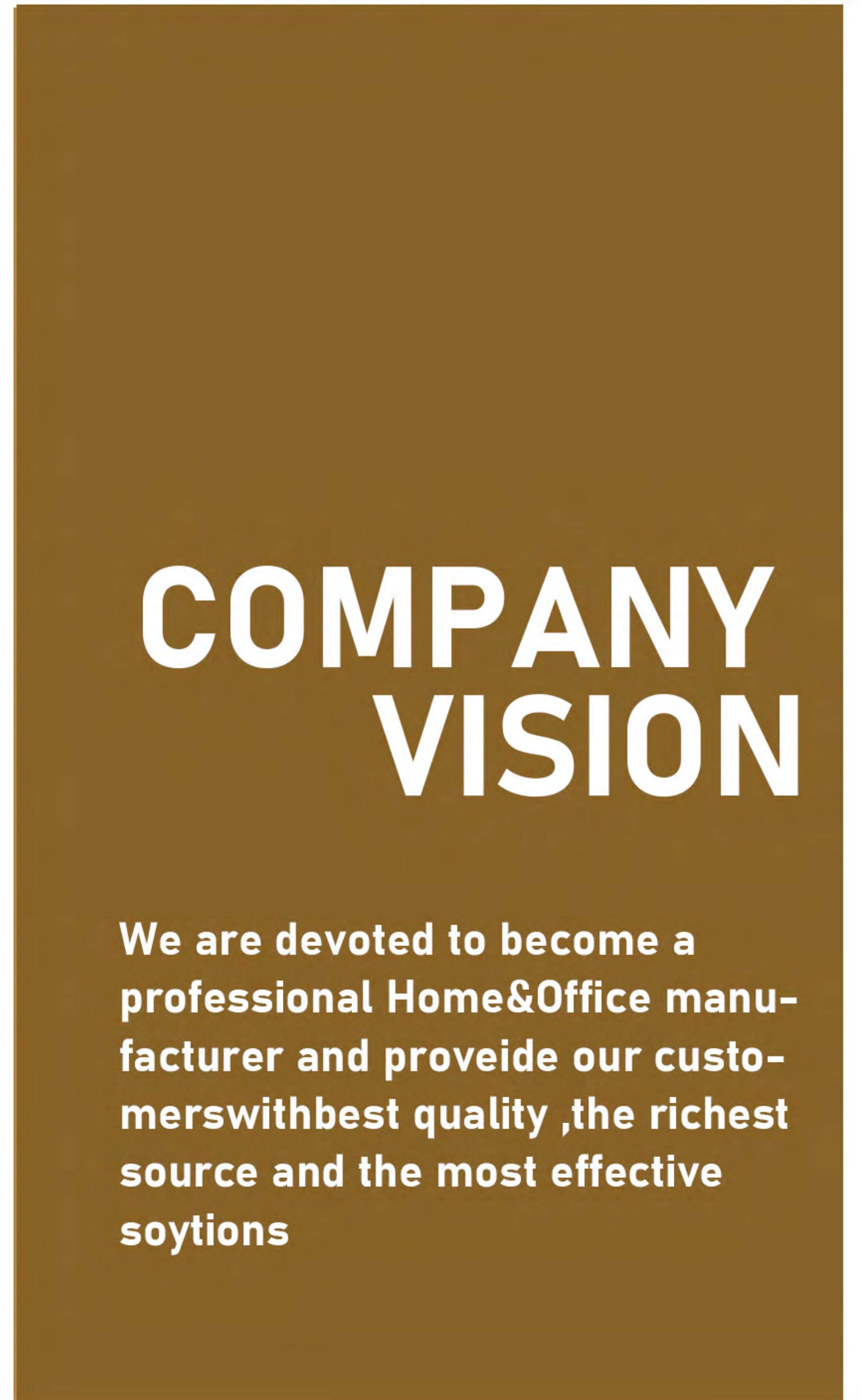

COMPANY VISION

We are devoted to become a professional Home&Office manufacturer and provide our customers with best quality, the richest source and the most effective solutions



**THE STEAM
CONTROL
PUNCH PRESS**

CONTENTS



Monitor/Desktop Riser

Height Adjustable standing Desk

Multi-functional desktop stand
and mobile presentation table

Interested parties are encouraged to email us at: bizdev@freeworldbrand.com with their requirements and for additional information to include pricing models and delivery terms.

Laptop Stand Series

Aluminum Foldable Laptop Stand



HH-B2

6 range portable laptop stand with phone holder

Material:	Aluminum alloy + Silicone
Suitable for laptops and tablets up to 15.6 inches	
Product Size:	240*170*145mm(unfold size)
Product Size:	240*45*15mm(fold size)
With Extra phone holder	



HH-B3

Material:	Aluminum alloy + silicone
Product Unfold size:	24.5*26*7.5cm
Product folded size:	26*7.5*0.65cm
Weight capacity:	10kg
For Most 10-17inch Laptop	
Unit N.W.:	200g



HH-B4

Material:	Aluminum alloy + silicone
Product fold size:	22*23.5*2.5cm
Stand size: 22*20*H	7.5cm, 10cm, 11.5cm, 12cm 12.5cm, 13cm(6 gear Adjustable)
Weight capacity:	8kg
For Most 10-17inch Laptop	
Unit N.W.:	350g



Easy folding
Convenient to carry

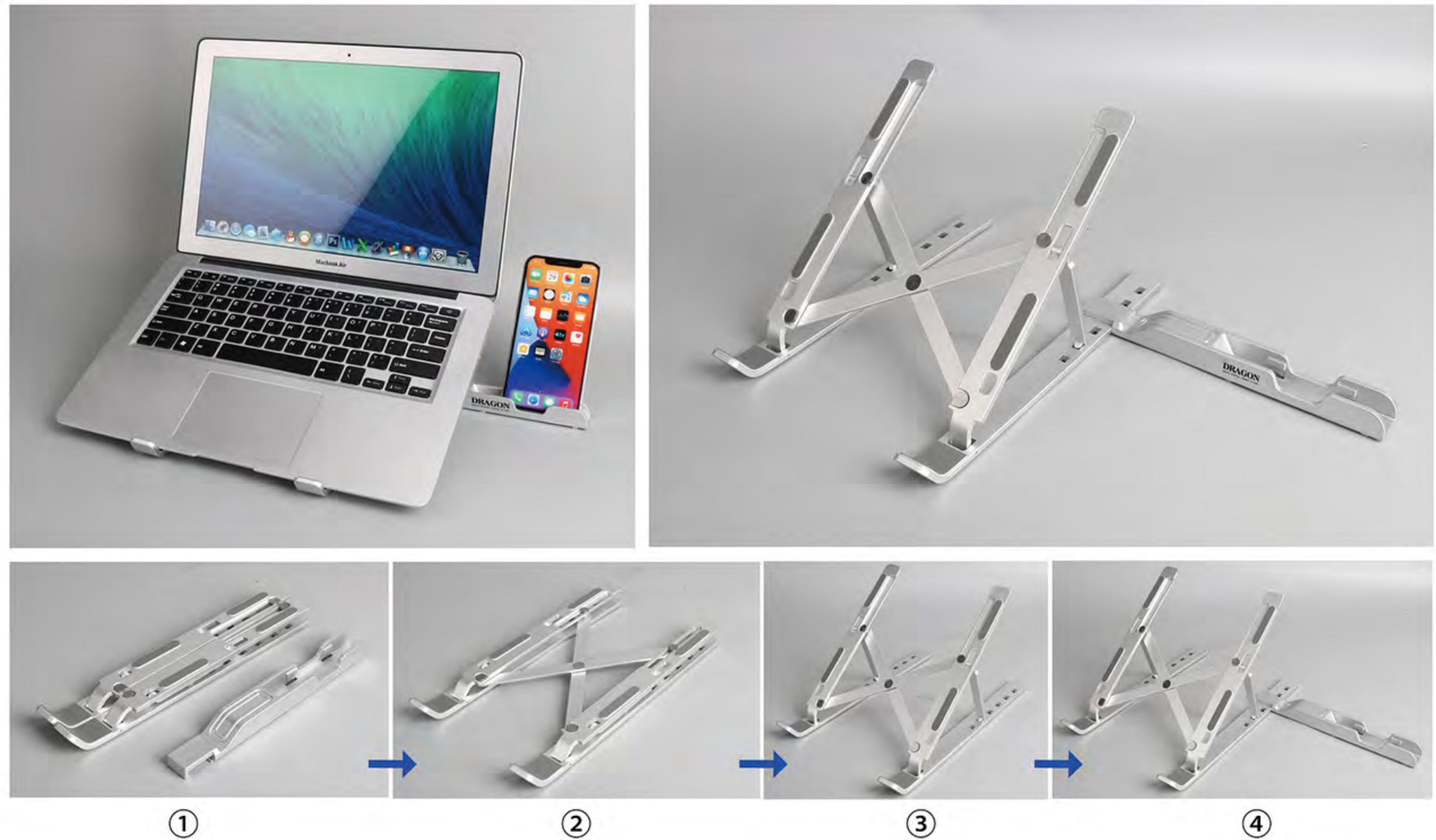

Easy folding
Convenient to carry



Solid Built Construction
Hollow Design Helps Heat Dissipation

6 mm thickness material
provides stronger support



Easy folding
Convenient to carry



Triangular fixing



Hollow design for heat dissipation



multifunctional

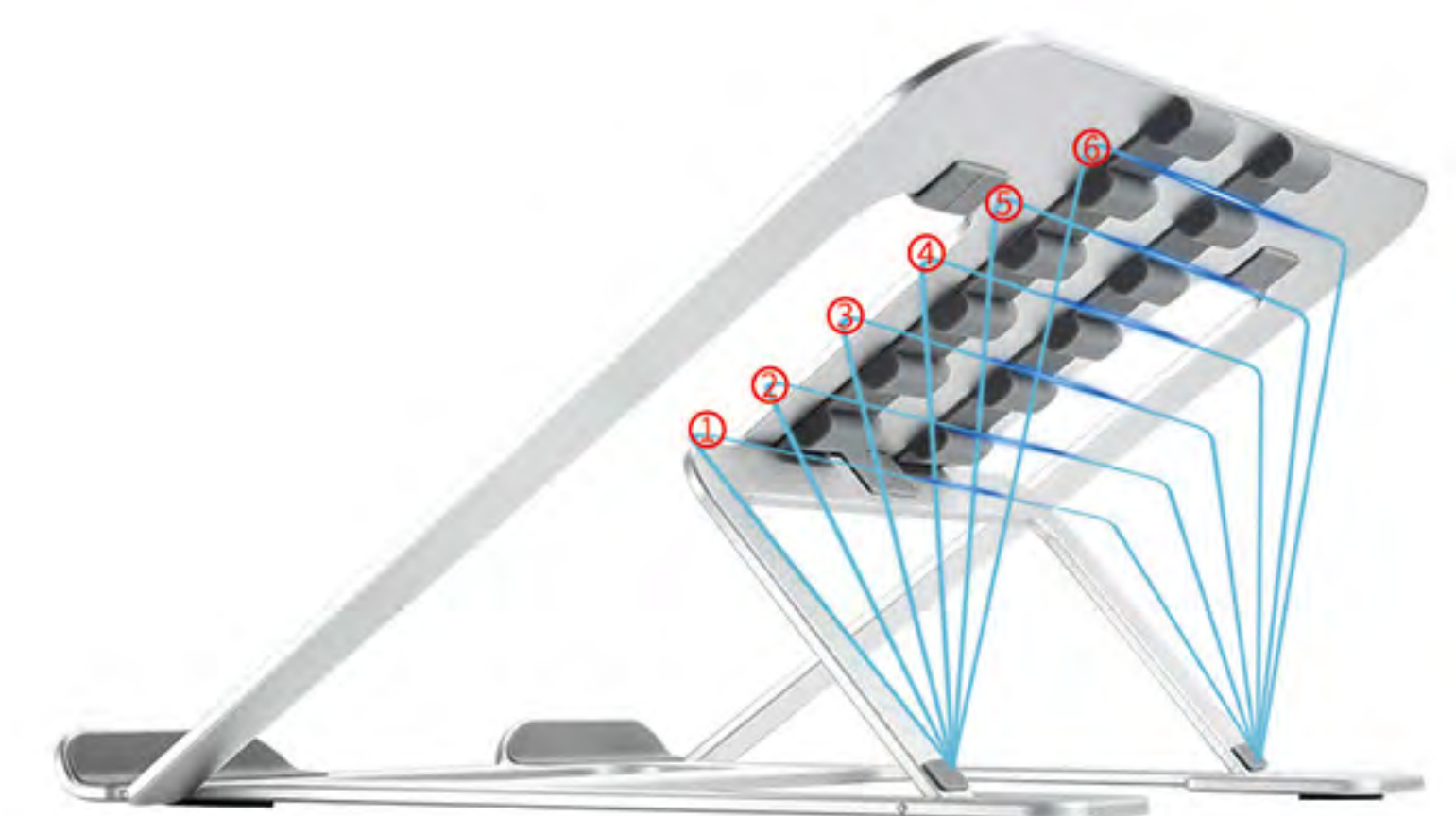

6-speed adjustment

Laptop Stand Series

Aluminum Foldable Laptop Stand



HH-B5

Material:	Aluminum alloy + silicone
Product size:	25.8*21.5*14.5cm
Weight capacity:	5kg
For Most 10-17inch Laptop	
Unit N.W.:	800g



HH-B6

Material:	Aluminum alloy + silicone
Product size:	24*28*2.5mm
Weight capacity:	5kg
For Most 10-17inch Laptop	
Unit N.W.:	580g



HH-B7

Material:	Aluminum alloy + silicone
Product size:	26*22*5cm
Base size:	22*19cm
Height adjustable range:	5-20cm
Weight capacity:	8kg
For Most 10-17inch Laptop	
Unit N.W.:	770g

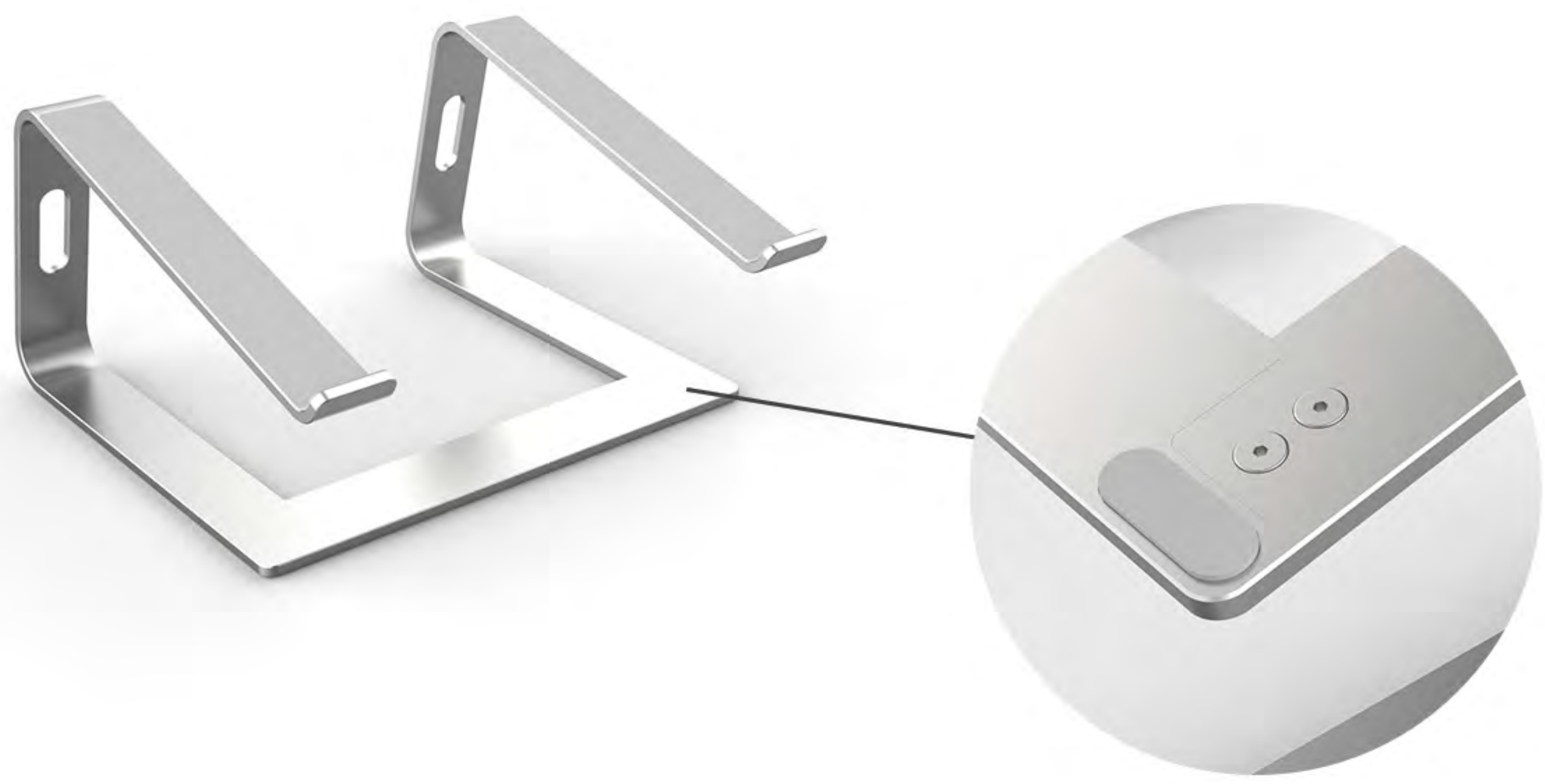

Detachable bottom



**Easy folding
Convenient to carry**



**Easy folding
Convenient to carry**



Laptop Stand Series

Aluminum Foldable Laptop Stand



HH-B8

Material:	Aluminum alloy + silicone
Product size:	26*22*5cm
Base size:	24*20cm
Height adjustable range:	5-18cm
Weight capacity:	8kg
For Most 10-17inch Laptop	
Unit N.W.:	640g



HH-B9

Material:	Aluminum alloy + silicone
Product size:	28*23*5cm
Base size:	23.5*19cm
Height adjustable range:	5-22cm
Weight capacity:	8kg
With 360° rotating base	
For Most 10-17inch Laptop	
Unit N.W.:	1.2kgs



HH-B10

Material:	Aluminum alloy + silicone
Product size(Unfold size):	24.2*21.2*30cm
Product size(Folded size):	24.2*22.9x5cm
Base size:	19.6*21.2cm
Height adjustable range:	5-30cm
Weight capacity:	10kg
For Most 10-17inch Laptop	
Unit N.W.:	722g



**Easy folding
Convenient to carry**



**Easy folding
Convenient to carry**

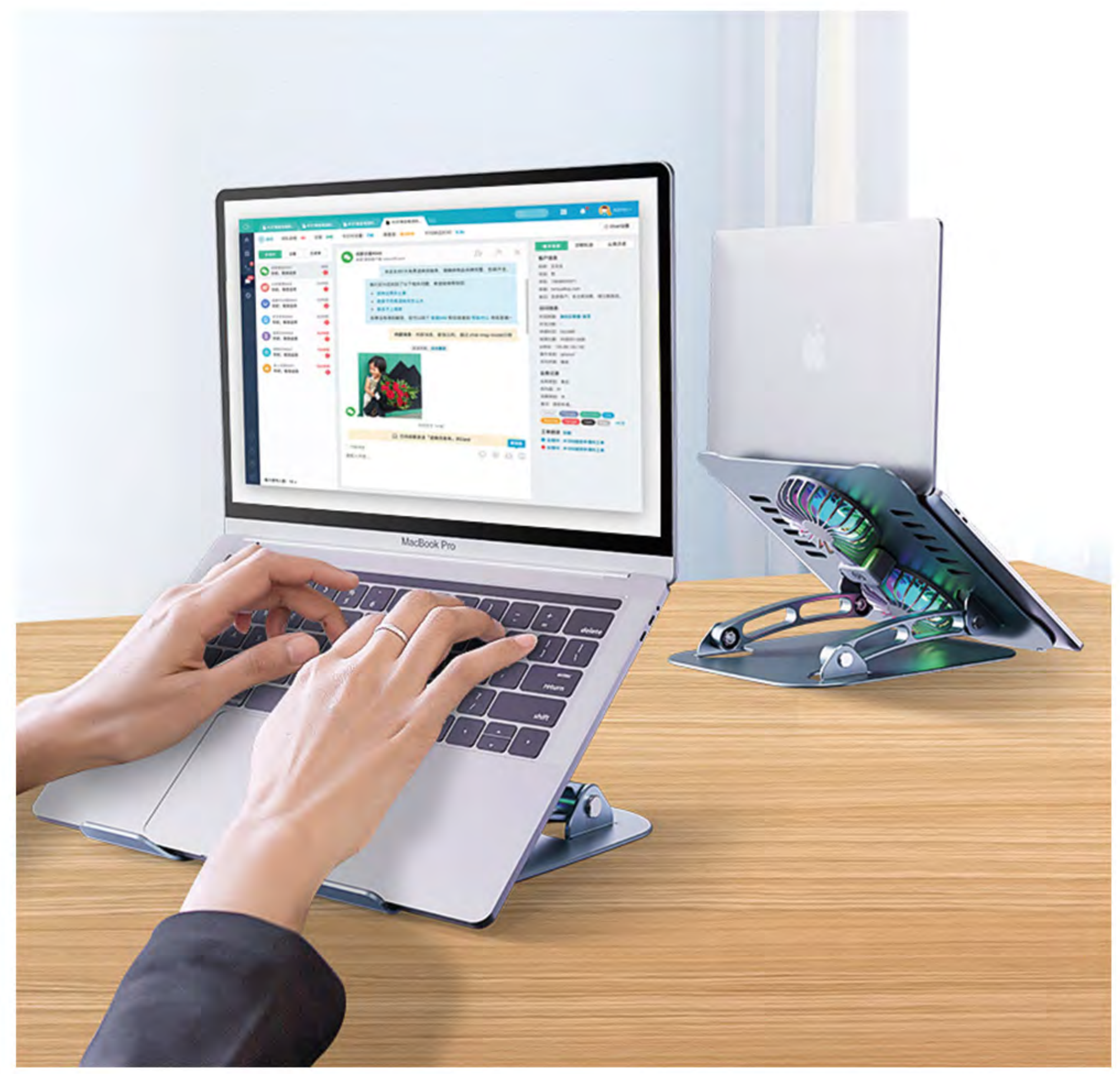

Laptop Stand Series

Aluminum Foldable Laptop Stand



HH-C11

Material:	Aluminum alloy + silicone
Product size:	26*22*5cm
Base size:	22*19cm
Height adjustable range:	5-18cm
Weight capacity:	8kg
With 360° rotating base	
For Most 10-17inch Laptop	
Unit N.W.:	690g



HH-C12

Material:	Aluminum alloy + silicone
Product size:	26*22*5cm
Base size:	22*19cm
Height adjustable range:	5-20cm
Weight capacity:	8kg
With 360° rotating base	
For Most 10-17inch Laptop	
Unit N.W.:	910g

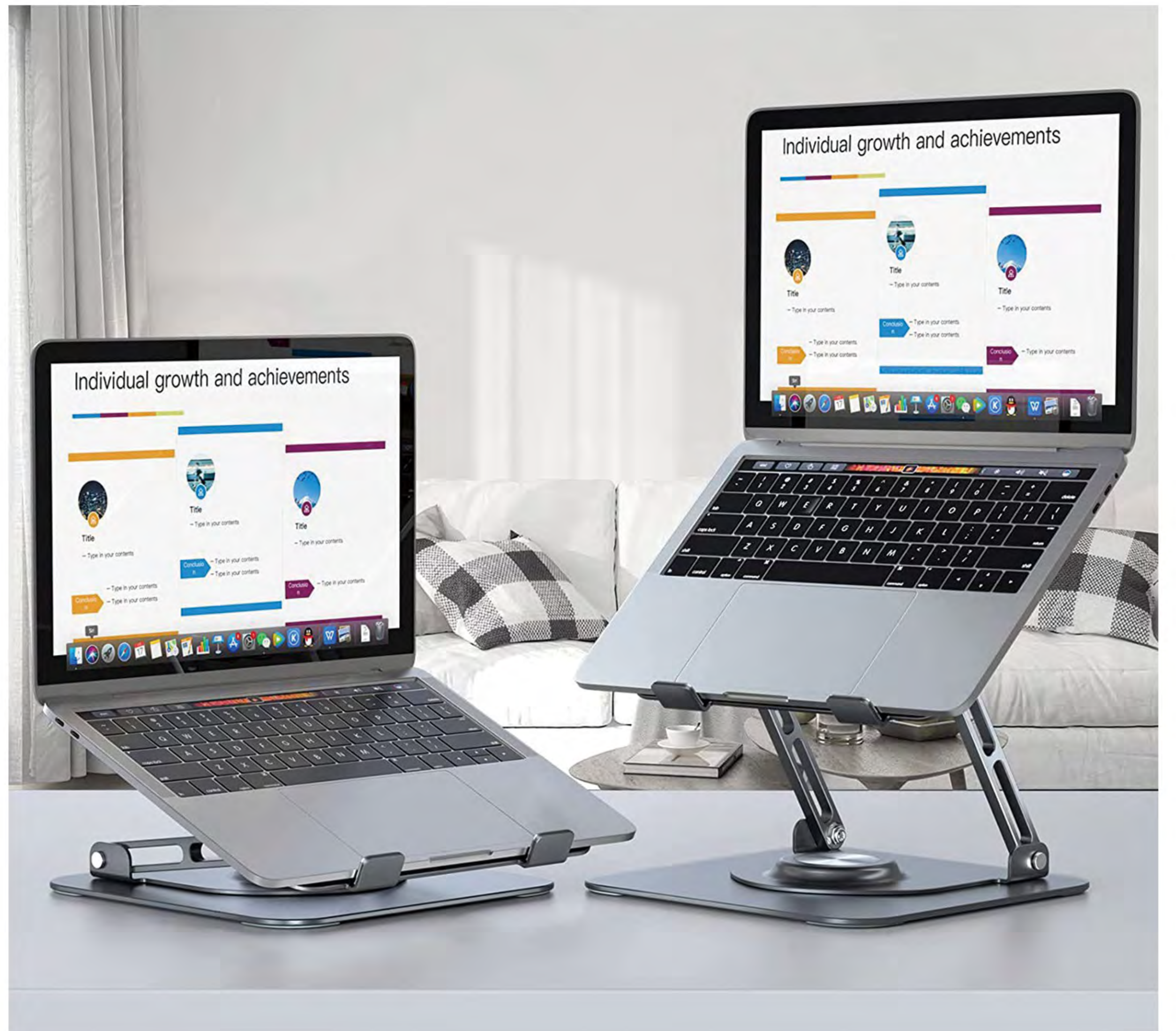

360° rotation

Adjusts to a comfortable angle

Laptop Stand Series

Aluminum Foldable Laptop Stand



CJ-L302

Material:	Aluminum alloy + silicone
Product size:	28*23*5cm
180° adjustable	
For Most 10-17inch Laptop	
Unit N.W.:	745 g



CJ-MT1361

Material:	Aluminum alloy + silicone
Product size:	15.5*14.5*5.6cm
180° adjustable 、 12-17cm height adjustment	
With 360° rotating base	
For Most 4-13inch Tablet/mobile phone	
Unit N.W.:	400g



Adjusts to a comfortable angle



Dual axis 180° adjustment



Lifting up and down



360° rotation



Laptop Stand Series

Aluminum Foldable Laptop Stand



CJ-MT134

Material:	Aluminum alloy + silicone
Product size:	20*14.5*5.5cm
180° adjustable	
For Most 4-13inch Mobile phone/tablet	
Unit N.W.:	470 g



CJ-MT1341

Material:	Aluminum alloy + silicone
Product size:	20*14.5*5.5cm
180° adjustable	
With 360° rotating base	
For Most 4-13inch Tablet/mobile phone	
Unit N.W.:	550g



Adjusts to a comfortable angle

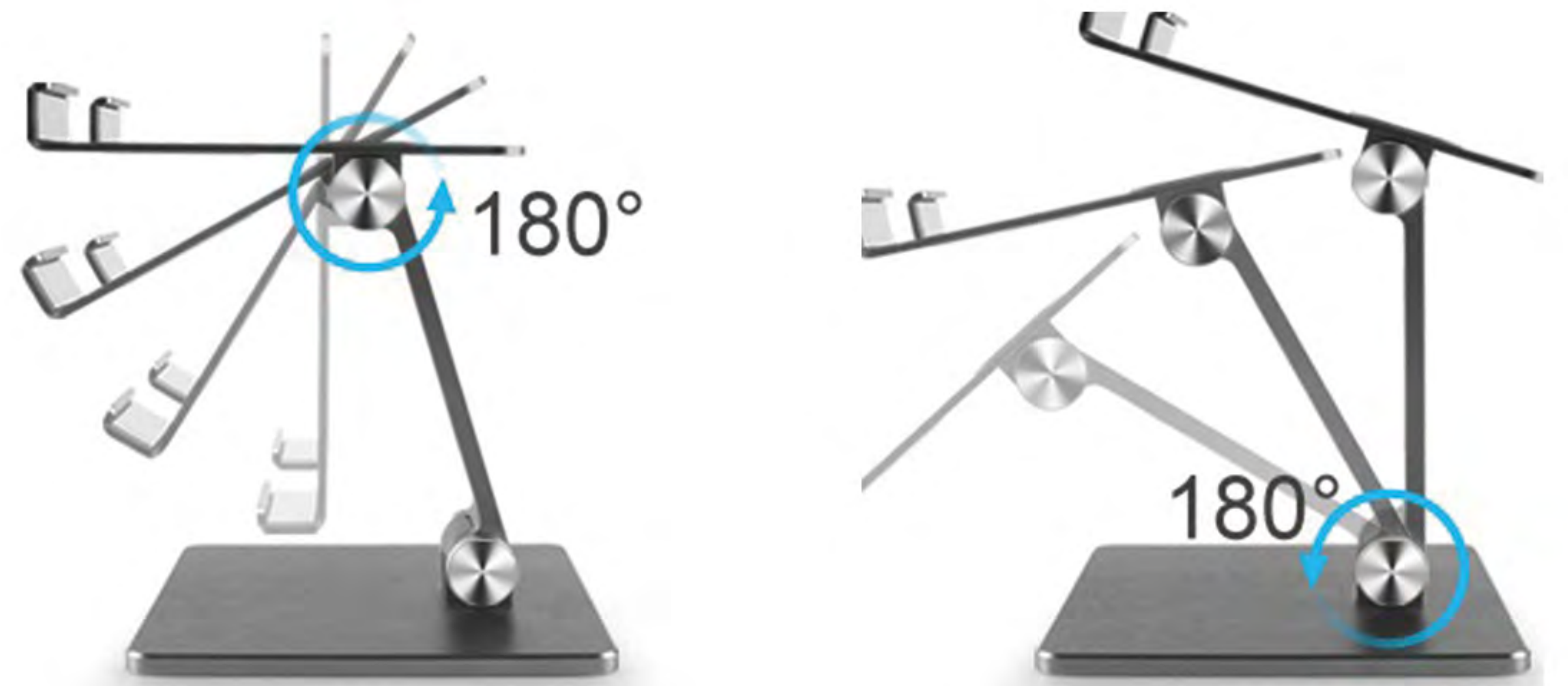

Dual axis 180° adjustment



Weighted base, anti-tip



360° rotation

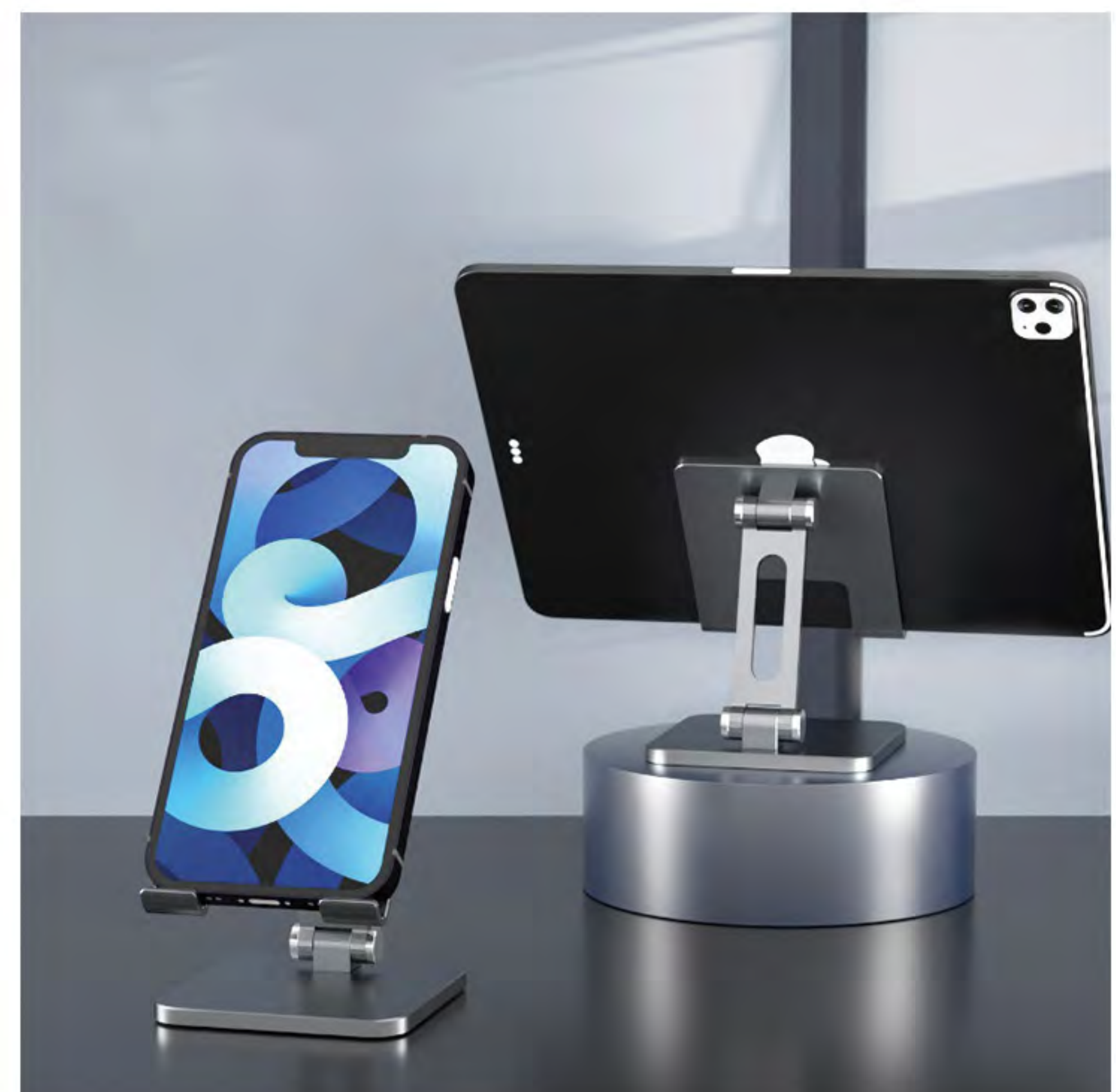

Laptop Stand Series

Aluminum Foldable Laptop Stand



HH-C13

Material:	Aluminum alloy + silicone
Product size:	22*24*26cm
Base size:	15.4*21cm
Height adjustable range:	15-26cm
Weight capacity:	10kg
For Most 10-17inch Laptop	



HH-C14

Material:	Aluminum alloy + silicone
Product size:	27*22.8*15cm
Base size:	23.5*19.5cm
Height adjustable range:	15-23cm
Weight capacity:	10kg
For Most 10-17inch Laptop	
Unit N.W.:	1.18kgs



HH-D536

Material:	Bamboo
Product size:	550*360*80mm
With a handle , With 2 card shots	
Weight capacity:	30kg
For Most 10-17inch Laptop	
Unit N.W.:	2.0kgs



10-17inch use



Space saving



Weight capacity 10kg

