



Global Traders: Operators of the Unconventional Inventory Liquidation Marketplace FreeWorldImports.com

---

## **FWI UNLISTED PRODUCTS | HIGHLY DISCOUNTED**

---

### **FWB PRODUCT -- UNRLPRD-070223-01:**

**GOURMIA DIGITAL STAINLESS STEEL TOASTER OVEN AIR FRYER - STAINLESS STEEL | PER 208 UNITS LOT | EXW: LOS ANGELES, CA | FWB DISCOUNTED PRICE: **\$41.50** PER UNIT**

Please [contact us](#) for additional information:



### **See**

**AMAZON LINK:** [https://www.amazon.com/Gourmia-Digital-Stainless-Steel-Toaster/dp/B08W1W8R7Y/ref=sr\\_1\\_6?hvadid=410035049676&hvdev=c&hvlocphy=9031532&hvnetw=g&hvqmt=e&hvrnd=10798450076446054099&hvtargid=kwd-854063282593&hydadcr=13988\\_11143891&keywords=gourmia+air+fryer+toaster+oven&qid=1688145655&sr=8-6](https://www.amazon.com/Gourmia-Digital-Stainless-Steel-Toaster/dp/B08W1W8R7Y/ref=sr_1_6?hvadid=410035049676&hvdev=c&hvlocphy=9031532&hvnetw=g&hvqmt=e&hvrnd=10798450076446054099&hvtargid=kwd-854063282593&hydadcr=13988_11143891&keywords=gourmia+air+fryer+toaster+oven&qid=1688145655&sr=8-6)

---

309 Fellowship Road | East Gate Center | Suite 200 | Mt. Laurel | NJ 08054

Web-Presence: <http://freeworldbrand.com> | Liquidation Marketplace: <https://freeworldimports.com>

Commodities Webstore: <https://commodities.freeworldbrand.com/>

Phone/Fax: 609-318-0570 | Email: [bizdev@freeworldbrand.com](mailto:bizdev@freeworldbrand.com)



Global Traders: Operators of the Unconventional Inventory Liquidation Marketplace FreeWorldImports.com

---

## **FWI UNLISTED PRODUCTS | HIGHLY DISCOUNTED**

---

### **FWB PRODUCT -- UNRLPRD-070223-02:**

**FIT CHOICE 1500W OSCILLATING SPACE HEATER | PER 4,000 UNITS LOT | EXW: LOS ANGELES, CA | FWB DISCOUNTED PRICE: **\$20.00** PER UNIT**

Please [contact us](#) for additional information:



### **See**

AMAZON LINK: <https://www.amazon.com/dp/B08RRWVMBC/?tag=lassowond-20&th=1>

---

309 Fellowship Road | East Gate Center | Suite 200 | Mt. Laurel | NJ 08054

Web-Presence: <http://freeworldbrand.com> | Liquidation Marketplace: <https://freeworldimports.com>

Commodities Webstore: <https://commodities.freeworldbrand.com/>

Phone/Fax: 609-318-0570 | Email: [bizdev@freeworldbrand.com](mailto:bizdev@freeworldbrand.com)



Global Traders: Operators of the Unconventional Inventory Liquidation Marketplace FreeWorldImports.com

---

## **FWI UNLISTED PRODUCTS | HIGHLY DISCOUNTED**

---

### **FWB PRODUCT -- UNRLPRD-070223-03:**

**WILSON PENTAGON SOCCER BALL, SIZE 3 | PER 450 UNITS LOT | EXW: LOS ANGELES, CA |**

**FWB DISCOUNTED PRICE: \$7.50 PER UNIT**

Please [contact us](#) for additional information:



### **See**

**AMAZON LINK:** <https://www.amazon.com/WILSON-Pentagon/dp/B07TLM7F3D?th=1&psc=1>

---

309 Fellowship Road | East Gate Center | Suite 200 | Mt. Laurel | NJ 08054

**Web-Presence:** <http://freeworldbrand.com> | **Liquidation Marketplace:** <https://freeworldimports.com>

Commodities Webstore: <https://commodities.freeworldbrand.com/>

**Phone/Fax:** 609-318-0570 | **Email:** bizdev@freeworldbrand.com



Global Traders: Operators of the Unconventional Inventory Liquidation Marketplace FreeWorldImports.com

---

## **FWI UNLISTED PRODUCTS | HIGHLY DISCOUNTED**

---

### **FWB PRODUCT -- UNRLPRD-070223-04:**

**NEW ALUMINUM CRUTCHES | PER 4,100 PAIRS LOT | EXW: LOS ANGELES, CA | FWB DISCOUNTED PRICE: **\$10.00** PER PAIR**

Please [contact us](#) for additional information:



- 8 Pairs/Case
- 24 Cases/Pallet
- 4,100 Pairs per 40ft container

---

309 Fellowship Road | East Gate Center | Suite 200 | Mt. Laurel | NJ 08054

Web-Presence: <http://freeworldbrand.com> | Liquidation Marketplace: <https://freeworldimports.com>

Commodities Webstore: <https://commodities.freeworldbrand.com/>

Phone/Fax: 609-318-0570 | Email: [bizdev@freeworldbrand.com](mailto:bizdev@freeworldbrand.com)



Global Traders: Operators of the Unconventional Inventory Liquidation Marketplace FreeWorldImports.com

## FWI UNLISTED PRODUCTS | HIGHLY DISCOUNTED

### FWB PRODUCT -- UNRLPRD-070123-01:

**IDENTIC™ MEN'S 3PK UNDERWEAR | PER 64,386 PACKS LOT | EXW: LOS ANGELES, CA | FWB DISCOUNTED PRICE: \$3.50 PER PACK**

Please [contact us](#) for additional information:

SKETCH	COMBOS	Quantities / Pack	Notes
	1.Combo Solid Black Solid Khaki Solid Navy	8070	
	2.Combo Solid Khaki AOP Grey Solid Khaki	7063	
	3.Combo AOP Navy Solid Navy AOP Navy	2951	
	4.Combo AOP Khaki 12899 PCs Solid Khaki 9503 PCs AOP Khaki 12899 PCs	11767	
	5.Combo Solid Khaki Solid Khaki Solid Khaki	171	
	6.Combo Solid Black AOP Navy Solid Black	1722	
	7.Combo Solid Navy Solid Navy Solid Navy	1686	
	8.Combo AOP Grey AOP Khaki AOP Grey	8255	

309 Fellowship Road | East Gate Center | Suite 200 | Mt. Laurel | NJ 08054

Web-Presence: <http://freeworldbrand.com> | Liquidation Marketplace: <https://freeworldimports.com>





Commodities Webstore: <https://commodities.freeworldbrand.com/>

Phone/Fax: 609-318-0570 | Email: [bizdev@freeworldbrand.com](mailto:bizdev@freeworldbrand.com)



Global Traders: Operators of the Unconventional Inventory Liquidation Marketplace FreeWorldImports.com

## FWI UNLISTED PRODUCTS | HIGHLY DISCOUNTED

	9.Combo AOP Grey Solid Black AOP Grey	6480	
	10.Combo AOP Grey Solid Black AOP Grey	3981	
	11.Combo Solid Black AOP Grey Solid Black	5778	
	12.Combo Solid Black Solid Black Solid Black	6462	
<b>Grand Total</b>		<b>64386</b>	

309 Fellowship Road | East Gate Center | Suite 200 | Mt. Laurel | NJ 08054

Web-Presence: <http://freeworldbrand.com> | Liquidation Marketplace: <https://freeworldimports.com>

Commodities Webstore: <https://commodities.freeworldbrand.com/>

Phone/Fax: 609-318-0570 | Email: [bizdev@freeworldbrand.com](mailto:bizdev@freeworldbrand.com)



Global Traders: Operators of the Unconventional Inventory Liquidation Marketplace FreeWorldImports.com

## **FWI UNLISTED PRODUCTS | HIGHLY DISCOUNTED**

### **FWB PRODUCT -- UNRLPRD-070123-02:**

**JUMP ROPE, TANGLE-FREE RAPID SPEED JUMPING ROPE CABLE WITH BALL BEARINGS FOR WOMEN, MEN, AND KIDS, ADJUSTABLE STEEL JUMP ROPE WORKOUT WITH FOAM HANDLES FOR FITNESS, HOME EXERCISE & SLIM BODY | PER 16,000 UNITS LOT | EXW: LOS ANGELES, CA | FWB DISCOUNTED PRICE: **\$2.50** PER UNIT**

Please [contact us](#) for additional information:



SOFT ON THE OUTSIDE AND STRONG ON THE INSIDE  
Strong steel wire rope coated with durable PVC material

ADJUST THE LENGTH EASILY.

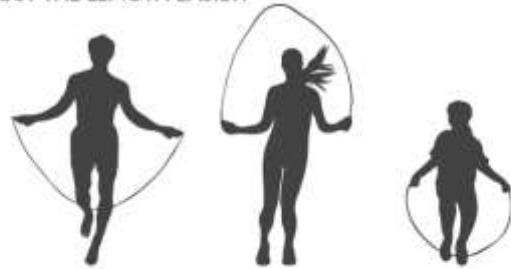

#### **PRODUCT DESCRIPTION**

- Durable & Adjustable Rope
- Jump Fast, Jump easily
- Ergonomic Foam Handles
- Get Fitness Anytime & Anywhere
- Portable & Easy to Carry

**See:**

[https://www.amazon.com/dp/B09DF9NWC7?ref\\_cm\\_sw\\_r\\_mwn\\_dp\\_C6A3KVDZLNQZJE7BGQV5](https://www.amazon.com/dp/B09DF9NWC7?ref_cm_sw_r_mwn_dp_C6A3KVDZLNQZJE7BGQV5)

309 Fellowship Road | East Gate Center | Suite 200 | Mt. Laurel | NJ 08054

Web-Presence: <http://freeworldbrand.com> | Liquidation Marketplace: <https://freeworldimports.com>

Commodities Webstore: <https://commodities.freeworldbrand.com/>

Phone/Fax: 609-318-0570 | Email: [bizdev@freeworldbrand.com](mailto:bizdev@freeworldbrand.com)



Global Traders: Operators of the Unconventional Inventory Liquidation Marketplace FreeWorldImports.com

## **FWI UNLISTED PRODUCTS | HIGHLY DISCOUNTED**

### **FWB PRODUCT -- UNRLPRD-070123-03:**

**GE AIR CONDITIONER – THREE (3) MODELS | PER 78 UNITS LOT | EXW: LOS ANGELES, CA |  
FWB DISCOUNTED PRICE: **\$160.50** PER UNIT**

Please [contact us](#) for additional information:

**GE AHE24DZ 24000BTU with Heater | 30 Units | Retail: \$1149.00**

[https://www.appliancesconnection.com/ge-ahe24dz.html?ref=GoogleShoppingPhysicalStock&gclid=CjoKQCQjw1\\_SkBhDwARIsANbGpFvWS1cVlhOfdb4iQr2kIOBarxoitgUac1Cstpl3CfzlmSo\\_pRuFlalaAiX9EALw\\_wcB](https://www.appliancesconnection.com/ge-ahe24dz.html?ref=GoogleShoppingPhysicalStock&gclid=CjoKQCQjw1_SkBhDwARIsANbGpFvWS1cVlhOfdb4iQr2kIOBarxoitgUac1Cstpl3CfzlmSo_pRuFlalaAiX9EALw_wcB)

**GE AHFK24BA 24000BTU | 15 Units | Retail: \$829.00**

[https://www.totalhomesupply.com/p/ge-ahfk24ba-24000-btu-class-smart-window-air-conditioner-with-remote-208-230v-energy-star-r32-refrigerant?gclid=CjoKQCQjw1\\_SkBhDwARIsANbGpFuKhZCLdw\\_lyloPgy4okZEZjJ7y3LTxDEgS8WXJxHI55pSjvuEaT9QaAupwEALw\\_wcB](https://www.totalhomesupply.com/p/ge-ahfk24ba-24000-btu-class-smart-window-air-conditioner-with-remote-208-230v-energy-star-r32-refrigerant?gclid=CjoKQCQjw1_SkBhDwARIsANbGpFuKhZCLdw_lyloPgy4okZEZjJ7y3LTxDEgS8WXJxHI55pSjvuEaT9QaAupwEALw_wcB)

**GE AHFK18BA 18000BTU | 33 Units | Retail: \$799.00**

[https://www.totalhomesupply.com/p/ge-ahfk18ba-18000-btu-smart-window-air-conditioner-with-remote-208-230v-energy-star-r32?gclid=CjoKQCQjw1\\_SkBhDwARIsANbGpFsCOR8QcDvLoj9lh7i7Ty2XvVk27Rtw7css8h7aa9fyixKm1-SopDwaAv6KEALw\\_wcB](https://www.totalhomesupply.com/p/ge-ahfk18ba-18000-btu-smart-window-air-conditioner-with-remote-208-230v-energy-star-r32?gclid=CjoKQCQjw1_SkBhDwARIsANbGpFsCOR8QcDvLoj9lh7i7Ty2XvVk27Rtw7css8h7aa9fyixKm1-SopDwaAv6KEALw_wcB)

### **FWB PRODUCT -- UNRLPRD-070123-04:**

**ROSS DEPT STORE CLOTHING (NEW LADIES CLOTHING) | PER 120,000 UNITS LOT | EXW:  
ANAHEIM, CA | FWB DISCOUNTED PRICE: **\$3.00** PER UNIT**

Please [contact us](#) for additional information to include images videos and manifest:

### **FWB PRODUCT -- UNRLPRD-070123-05:**

**TOMMY HILFIGER BELTS | PER 150 UNITS LOT | EXW: LOS ANGELES, CA | FWB DISCOUNTED  
PRICE: **\$21.00** PER UNIT**

Please [contact us](#) for additional information:



309 Fellowship Road | East Gate Center | Suite 200 | Mt. Laurel | NJ 08054

Web-Presence: <http://freeworldbrand.com> | Liquidation Marketplace: <https://freeworldimports.com>

Commodities Webstore: <https://commodities.freeworldbrand.com/>

Phone/Fax: 609-318-0570 | Email: [bizdev@freeworldbrand.com](mailto:bizdev@freeworldbrand.com)





Global Traders: Operators of the Unconventional Inventory Liquidation Marketplace FreeWorldImports.com

---

## **FWI UNLISTED PRODUCTS | HIGHLY DISCOUNTED**

---

### **FWB PRODUCT -- UNRLPRD-070123-06:**

**TACKLIFE ELECTRIC CORDLESS SCREWDRIVER RECHARGEABLE WITH LED LIGHT, 10 PCS SCREWDRIVER BITS, POWER INDICATOR 3.6V - SDP60DC | PER 1,900 UNITS LOT | EXW: LOS ANGELES, CA | FWB DISCOUNTED PRICE: **\$9.50** PER UNIT**

Please [contact us](#) for additional information:

#### **See**

<https://www.walmart.com/ip/TACKLIFE-Electric-Cordless-Screwdriver-Rechargeable-with-LED-Light-10-Pcs-Screwdriver-Bits-Power-Indicator-3-6V-SDP60DC/155698273>  
<<https://www.walmart.com/ip/TACKLIFE-Electric-Cordless-Screwdriver-Rechargeable-with-LED-Light-10-Pcs-Screwdriver-Bits-Power-Indicator-3-6V-SDP60DC/155698273>>

### **FWB PRODUCT -- UNRLPRD-070123-07:**

**PAINT MARK REAL BRUSH PENS, 24 COLORS FOR WATERCOLOR PAINTING WITH FLEXIBLE NYLON BRUSH TIPS, CALLIGRAPHY AND DRAWING WITH WATER BRUSH, PAINT MARKERS FOR COLORING | PER 5,647 UNITS LOT | EXW: LOS ANGELES, CA | FWB DISCOUNTED PRICE: **\$8.50** PER UNIT**

Please [contact us](#) for additional information:

#### **See**

<https://www.walmart.com/ip/Paint-Mark-Real-Brush-Pens-24-Colors-Watercolor-Painting-Flexible-Nylon-Tips-Calligraphy-Drawing-Water-Brush-Markers-Coloring/283668749>  
<<https://www.walmart.com/ip/Paint-Mark-Real-Brush-Pens-24-Colors-Watercolor-Painting-Flexible-Nylon-Tips-Calligraphy-Drawing-Water-Brush-Markers-Coloring/283668749>>

### **FWB PRODUCT -- UNRLPRD-070123-08:**

**COLEMAN CHILLER MEDIUM ICE PACK, BLUE | PER 43,710 UNITS LOT | EXW: LOS ANGELES, CA | FWB DISCOUNTED PRICE: **\$3.50** PER UNIT**

Please [contact us](#) for additional information:

#### **See**

[https://www.walmart.com/ip/Coleman-Chiller-Medium-Ice-Pack-Blue/282168967?irgwc=1&sourceid=imp\\_xoZwLTQJNxyNTjR3Vw05U23%3AUkF2wRxxw3rCXYo&veh=aff&wmlspartner=imp\\_258082&clickid=xoZwLTQJNxyNTjR3Vw05U23%3AUkF2wRxxw3rCXYo&sharedid=&affiliates\\_ad\\_id=1285207&campaign\\_id=9383%20%3Chttps://www.walmart.com/ip/Coleman-Chiller-Medium-Ice-Pack-Blue/282168967?irgwc=1&sourceid=imp\\_xoZwLTQJNxyNTjR3Vw05U23%3AUkF2wRxxw3rCXYo&veh=aff&wmlspartner=imp\\_258082&clickid=xoZwLTQJNxyNTjR3Vw05U23%3AUkF2wRxxw3rCXYo&sharedid=&affiliates\\_ad\\_id=1285207&campaign\\_id=9383](https://www.walmart.com/ip/Coleman-Chiller-Medium-Ice-Pack-Blue/282168967?irgwc=1&sourceid=imp_xoZwLTQJNxyNTjR3Vw05U23%3AUkF2wRxxw3rCXYo&veh=aff&wmlspartner=imp_258082&clickid=xoZwLTQJNxyNTjR3Vw05U23%3AUkF2wRxxw3rCXYo&sharedid=&affiliates_ad_id=1285207&campaign_id=9383%20%3Chttps://www.walmart.com/ip/Coleman-Chiller-Medium-Ice-Pack-Blue/282168967?irgwc=1&sourceid=imp_xoZwLTQJNxyNTjR3Vw05U23%3AUkF2wRxxw3rCXYo&veh=aff&wmlspartner=imp_258082&clickid=xoZwLTQJNxyNTjR3Vw05U23%3AUkF2wRxxw3rCXYo&sharedid=&affiliates_ad_id=1285207&campaign_id=9383)

---

309 Fellowship Road | East Gate Center | Suite 200 | Mt. Laurel | NJ 08054

Web-Presence: <http://freeworldbrand.com> | Liquidation Marketplace: <https://freeworldimports.com>

Commodities Webstore: <https://commodities.freeworldbrand.com/>

Phone/Fax: 609-318-0570 | Email: [bizdev@freeworldbrand.com](mailto:bizdev@freeworldbrand.com)



Global Traders: Operators of the Unconventional Inventory Liquidation Marketplace FreeWorldImports.com

---

## **FWI UNLISTED PRODUCTS | HIGHLY DISCOUNTED**

---

### **FWB PRODUCT -- UNRLPRD-070123-09:**

**20X39 WATERPROOF AND STAIN-RESISTANT ANTI-FATIGUE MATS | PER 4,400 UNITS LOT | EXW: TORONTO, CA | FWB DISCOUNTED PRICE: **\$9.50** PER UNIT**

Please [contact us](#) for additional information:



### **See**

**TARGET LINK:** <https://www.target.com/p/sky-solutions-anti-fatigue-cushioned-3-4-inch-floor-mat-20-x-39-black/-/A-86261917>

**AMAZON LINK:** <https://www.amazon.com/dp/B00M8O122G?th=1>

---

309 Fellowship Road | East Gate Center | Suite 200 | Mt. Laurel | NJ 08054

**Web-Presence:** <http://freeworldbrand.com> | **Liquidation Marketplace:** <https://freeworldimports.com>

Commodities Webstore: <https://commodities.freeworldbrand.com/>

**Phone/Fax:** 609-318-0570 | **Email:** bizdev@freeworldbrand.com



Global Traders: Operators of the Unconventional Inventory Liquidation Marketplace FreeWorldImports.com

## **FWI UNLISTED PRODUCTS | HIGHLY DISCOUNTED**

### **FWB PRODUCT -- UNRLPRD-070123-10:**

**ELECTRIC RAZOR FOR WOMEN - WOMENS SHAVER BIKINI TRIMMER BODY HAIR REMOVAL FOR LEGS AND UNDERARMS RECHARGEABLE WET AND DRY PAINLESS CORDLESS WITH LED LIGHT, BLUE | PER 2,000 UNITS LOT | EXW: LOS ANGELES, CA | FWB DISCOUNTED PRICE: **\$13.75** PER UNIT**

Please [contact us](#) for additional information:

**FLEURIZE**  
Women's Shaver and Bikini Trimmer

Step out in confidence and endorse hair-free, smooth skin with your very own personal grooming tool.



### **3-in-1 Unique Blade Design**

Three ultra-sharp blades follows your body's different edges & contours for a quick and comfortable shave. It customizes your overall shaving experience to better suit your body's curves.

Curved blade  
Straight Blade  
Floating Blade Foil

### **Seamlessly Smooth & Safe**

Underarms  
Legs  
Back  
Bikini Area  
Arms

309 Fellowship Road | East Gate Center | Suite 200 | Mt. Laurel | NJ 08054

Web-Presence: <http://freeworldbrand.com> | Liquidation Marketplace: <https://freeworldimports.com>

Commodities Webstore: <https://commodities.freeworldbrand.com/>

Phone/Fax: 609-318-0570 | Email: [bizdev@freeworldbrand.com](mailto:bizdev@freeworldbrand.com)



Global Traders: Operators of the Unconventional Inventory Liquidation Marketplace FreeWorldImports.com

---

## **FWI UNLISTED PRODUCTS | HIGHLY DISCOUNTED**

---

### **FWB PRODUCT -- UNRLPRD-070123-11:**

**GABBA GOODS SAFE SOUNDS KIDS HEADPHONES | PER 9,240 UNITS LOT | EXW: LOS ANGELES, CA | FWB DISCOUNTED PRICE: \$6.00 PER UNIT**

***BREAKDOWN: PINK: 6,090 Units | BLUE: 3,150 Units***

***Please [contact us](#) for additional information:***



**See**

**EBAY LINK: <https://www.ebay.com/itm/185628530783>**

---

309 Fellowship Road | East Gate Center | Suite 200 | Mt. Laurel | NJ 08054

**Web-Presence: <http://freeworldbrand.com> | Liquidation Marketplace: <https://freeworldimports.com>**

**Commodities Webstore: <https://commodities.freeworldbrand.com/>**

**Phone/Fax: 609-318-0570 | Email: [bizdev@freeworldbrand.com](mailto:bizdev@freeworldbrand.com)**



Global Traders: Operators of the Unconventional Inventory Liquidation Marketplace FreeWorldImports.com

## FWI UNLISTED PRODUCTS | HIGHLY DISCOUNTED

### FWB PRODUCT -- UNRLPRD-070123-12:

HOUSE GUARD WHITE PATIO DOOR HANDLE SET WITH CYLINDER LOCK, SUITABLE FOR REPLACEMENT SLIDING PATIO DOORS LOCK 3-15/16" SCREW HOLE SPACING. CHOICES THAT ADD A UNIQUE TOUCH TO YOUR PATIO GLASS SLIDING DOOR. | PER 4,000 UNITS LOT | EXW: LOS ANGELES, CA | FWB DISCOUNTED PRICE: **\$6.50** PER UNIT

Please [contact us](#) for additional information:

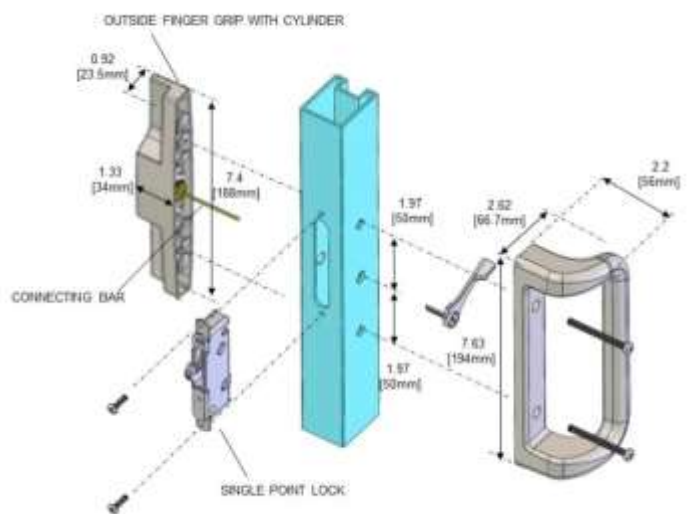

### See

AMAZON LINK: [https://www.amazon.com/House-Guard-Cylinder-Replacement-Spacing-Choices/dp/B0B1F7DVKM/ref=asc\\_df\\_B0B1F7DVKM/?tag=hyprod-20&linkCode=df0&hvadid=647104238787&hvpos=&hvnetw=g&hvrand=6114183291039196519&hvpon=&hvptwo=&hvqmt=&hvdev=c&hvdvcmdl=&hvlocint=&hvlocphy=9031532&hvtargid=pla-1799642594566&gclid=EA1aIQobChMijq2M7sLr\\_wlVDiKtBh1xQwtdEAQYAIBEGJfqvD\\_BwE&th=1](https://www.amazon.com/House-Guard-Cylinder-Replacement-Spacing-Choices/dp/B0B1F7DVKM/ref=asc_df_B0B1F7DVKM/?tag=hyprod-20&linkCode=df0&hvadid=647104238787&hvpos=&hvnetw=g&hvrand=6114183291039196519&hvpon=&hvptwo=&hvqmt=&hvdev=c&hvdvcmdl=&hvlocint=&hvlocphy=9031532&hvtargid=pla-1799642594566&gclid=EA1aIQobChMijq2M7sLr_wlVDiKtBh1xQwtdEAQYAIBEGJfqvD_BwE&th=1)

309 Fellowship Road | East Gate Center | Suite 200 | Mt. Laurel | NJ 08054

Web-Presence: <http://freeworldbrand.com> | Liquidation Marketplace: <https://freeworldimports.com>

Commodities Webstore: <https://commodities.freeworldbrand.com/>

Phone/Fax: 609-318-0570 | Email: [bizdev@freeworldbrand.com](mailto:bizdev@freeworldbrand.com)



Global Traders: Operators of the Unconventional Inventory Liquidation Marketplace FreeWorldImports.com

---

## **FWI UNLISTED PRODUCTS | HIGHLY DISCOUNTED**

---

### **FWB PRODUCT -- UNRLPRD-070123-13:**

**AOA & OBSOO AND GUNSCROSS BEACH & MOUNTAIN BIKE | PER 399 UNITS LOT | EXW: LOS ANGELES, CA | FWB DISCOUNTED PRICE: **\$90.00** PER UNIT**

Please [contact us](#) for additional information to include manifest:



---

309 Fellowship Road | East Gate Center | Suite 200 | Mt. Laurel | NJ 08054

Web-Presence: <http://freeworldbrand.com> | Liquidation Marketplace: <https://freeworldimports.com>

Commodities Webstore: <https://commodities.freeworldbrand.com/>

Phone/Fax: 609-318-0570 | Email: [bizdev@freeworldbrand.com](mailto:bizdev@freeworldbrand.com)



Global Traders: Operators of the Unconventional Inventory Liquidation Marketplace FreeWorldImports.com

## **FWI UNLISTED PRODUCTS | HIGHLY DISCOUNTED**

### **FWB PRODUCT -- UNRLPRD-070123-14:**

**CORDLESS ROBOTIC POOL CLEANER, AUTOMATIC POOL VACUUM WITH 60-90 MINS WORKING TIME, RECHARGEABLE BATTERY, IPX8 WATERPROOF FOR ABOVE/IN-GROUND SWIMMING POOLS UP TO 861 SQ FT | PER 120 UNITS LOT | EXW: LOS ANGELES, CA | FWB DISCOUNTED PRICE: **\$95.00** PER UNIT**

Please [contact us](#) for additional information:

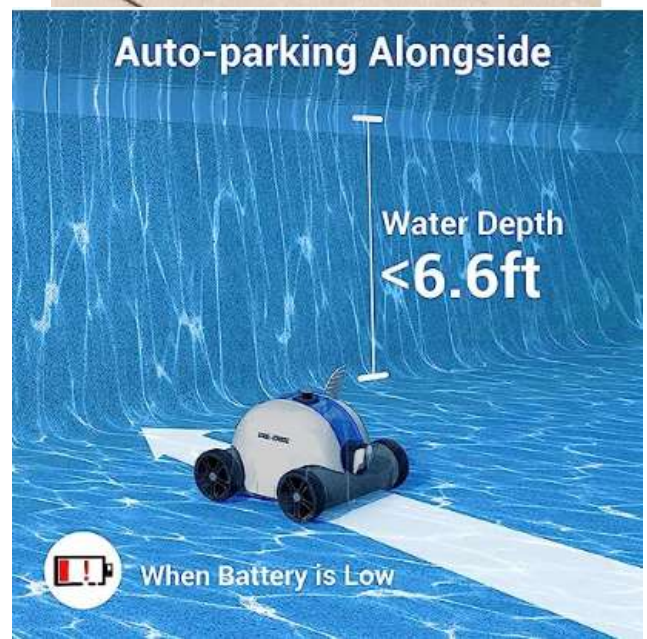

### **See**

**AMAZON LINK:**

[https://www.amazon.com/dp/B088JWRWGM?ref\\_=cm\\_sw\\_r\\_apin\\_dp\\_13QHCZA7MTXAQ68BCYTB](https://www.amazon.com/dp/B088JWRWGM?ref_=cm_sw_r_apin_dp_13QHCZA7MTXAQ68BCYTB)

309 Fellowship Road | East Gate Center | Suite 200 | Mt. Laurel | NJ 08054

Web-Presence: <http://freeworldbrand.com> | Liquidation Marketplace: <https://freeworldimports.com>

Commodities Webstore: <https://commodities.freeworldbrand.com/>

Phone/Fax: 609-318-0570 | Email: [bizdev@freeworldbrand.com](mailto:bizdev@freeworldbrand.com)



Global Traders: Operators of the Unconventional Inventory Liquidation Marketplace FreeWorldImports.com

## **FWI UNLISTED PRODUCTS | HIGHLY DISCOUNTED**

### **FWB PRODUCT -- UNRLPRD-070123-15:**

**FLYBIRD ADJUSTABLE BENCH, UTILITY WEIGHT BENCH FOR FULL BODY WORKOUT- MULTI-PURPOSE FOLDABLE INCLINE BENCH (BLACK) | PER 2,500 UNITS LOT | EXW: LOS ANGELES, CA | FWB DISCOUNTED PRICE: **\$28.00** PER UNIT**

Please [contact us](#) for additional information:



**See**

**AMAZON LINK:**

[https://www.amazon.com/dp/B07HNLBZ4Y?ref\\_=cm\\_sw\\_r\\_mwn\\_dp\\_W5PMEN63B587MV5XY69A](https://www.amazon.com/dp/B07HNLBZ4Y?ref_=cm_sw_r_mwn_dp_W5PMEN63B587MV5XY69A)

309 Fellowship Road | East Gate Center | Suite 200 | Mt. Laurel | NJ 08054

Web-Presence: <http://freeworldbrand.com> | Liquidation Marketplace: <https://freeworldimports.com>

Commodities Webstore: <https://commodities.freeworldbrand.com/>

Phone/Fax: 609-318-0570 | Email: [bizdev@freeworldbrand.com](mailto:bizdev@freeworldbrand.com)





Global Traders: Operators of the Unconventional Inventory Liquidation Marketplace FreeWorldImports.com

---

## **FWI UNLISTED PRODUCTS | HIGHLY DISCOUNTED**

---

### **FWB PRODUCT -- UNRLPRD-010623-01:**

**ROCKPORT™ & DR SCHOLL'S™ MEN'S ASSORTED SHOES | PER 6,250 PAIRS LOT | EXW: LOS ANGELES | FWB DISCOUNTED PRICE: **\$22.50** PER UNIT**

Please [contact us](#) for additional information:



**NOTE:** All Shoes are new in boxes and mixed in styles and sizes with UPC number

**Packaging:** 10 Pairs per case | 25 Cases per pallet (250 Pairs)

Details with respect to size & styles breakdown is unavailable

---

309 Fellowship Road | East Gate Center | Suite 200 | Mt. Laurel | NJ 08054

Web-Presence: <http://freeworldbrand.com> | Liquidation Marketplace: <https://freeworldimports.com>

Commodities Webstore: <https://commodities.freeworldbrand.com/>

Phone/Fax: 609-318-0570 | Email: [bizdev@freeworldbrand.com](mailto:bizdev@freeworldbrand.com)



Global Traders: Operators of the Unconventional Inventory Liquidation Marketplace FreeWorldImports.com

## **FWI UNLISTED PRODUCTS | HIGHLY DISCOUNTED**

### **FWB PRODUCT -- UNRLPRD-010623-02:**

**LEVOIT™ HUMIDIFIERS CLOSEOUT | PER 1,980 UNITS LOT | EXW: LOS ANGELES**

**FWB DISCOUNTED PRICE: \$15.00 PER UNIT**

Please [contact us](#) for additional information:



*LEVOIT™ Humidifiers for Bedroom Large Room, 3L Cool Mist Top Fill Oil Diffuser for Baby Nursery and Plants, 360° Nozzle, Quiet Rapid Ultrasonic Humidification for Home Whole House Currently Retail at Amazon and other for: \$35.00+*

309 Fellowship Road | East Gate Center | Suite 200 | Mt. Laurel | NJ 08054

Web-Presence: <http://freeworldbrand.com> | Liquidation Marketplace: <https://freeworldimports.com>

Commodities Webstore: <https://commodities.freeworldbrand.com/>

Phone/Fax: 609-318-0570 | Email: [bizdev@freeworldbrand.com](mailto:bizdev@freeworldbrand.com)



Global Traders: Operators of the Unconventional Inventory Liquidation Marketplace FreeWorldImports.com

## **FWI UNLISTED PRODUCTS | HIGHLY DISCOUNTED**

### **FWB PRODUCT -- UNRLPRD-010623-03:**

**DASH™ SHAVED ICE MAKER + SLUSHIE MACHINE | PER 640 UNITS LOT | EXW: LOS ANGELES**

**FWB DISCOUNTED PRICE: \$12.50 PER UNIT**

Please [contact us](#) for additional information:



DASH™ Shaved Ice Maker + Slushie Machine with Stainless Steel Blades for Snow Cone, Margarita + Frozen Cocktails, Organic, Sugar Free, Flavored Healthy Snacks for Kids & Adults. Currently Retail at Amazon and other for: \$32.00+

309 Fellowship Road | East Gate Center | Suite 200 | Mt. Laurel | NJ 08054

Web-Presence: <http://freeworldbrand.com> | Liquidation Marketplace: <https://freeworldimports.com>

Commodities Webstore: <https://commodities.freeworldbrand.com/>

Phone/Fax: 609-318-0570 | Email: [bizdev@freeworldbrand.com](mailto:bizdev@freeworldbrand.com)



Global Traders: Operators of the Unconventional Inventory Liquidation Marketplace FreeWorldImports.com

## **FWI UNLISTED PRODUCTS | HIGHLY DISCOUNTED**

### **FWB PRODUCT -- UNRLPRD-010623-04:**

**MEN'S & WOMEN'S WINTER PADDING JACKETS | PER 8,976 PIECES LOT | EXW: LOS ANGELES**

**FWB DISCOUNTED PRICE: **\$8.50** PER PIECE**

Please [contact us](#) for additional information:



**Size:** S-M-L-XL | **Material:** 100% Polyester

**Packaging:** 24 pieces per case with same color

#### **BREAKDOWN**

- **MEN'S :** - **Green:** 768 Pieces | **Grey:** 768 Pieces | **Blue:** 792 Pieces | **Khaki:** 1,032 Pieces | **Black:** 792 Pieces
- **WOMEN'S :** - **Red:** 960 Pieces | **Black:** 480 Pieces | **Green:** 1,104 Pieces | **Khaki:** 1,032 Pieces | **Coffee:** 720 Pieces | **Khaki:** 1152 Pieces | **Grey:** 408 Pieces

309 Fellowship Road | East Gate Center | Suite 200 | Mt. Laurel | NJ 08054

**Web-Presence:** <http://freeworldbrand.com> | **Liquidation Marketplace:** <https://freeworldimports.com>

**Commodities Webstore:** <https://commodities.freeworldbrand.com/>

**Phone/Fax:** 609-318-0570 | **Email:** bizdev@freeworldbrand.com



Global Traders: Operators of the Unconventional Inventory Liquidation Marketplace FreeWorldImports.com

## **FWI UNLISTED PRODUCTS | HIGHLY DISCOUNTED**

### **FWB PRODUCT -- UNRLPRD-010623-05:**

**PATIO & OUTDOOR HEATER | PER 2,100 UNITS LOT | EXW: LOS ANGELES**

**FWB DISCOUNTED PRICE: \$29.50 PER UNIT**

Please [contact us](#) for additional information:



**Outdoor & Indoor Use**



500W

1000W

**3-HEAT SETTINGS**



1500W



500W

1000W

**3-HEAT SETTINGS**



1500W



**IP34 WATERPROOF**

Perfect for Outdoor Use

Currently Retail at Amazon and other for: \$99.00+

309 Fellowship Road | East Gate Center | Suite 200 | Mt. Laurel | NJ 08054

Web-Presence: <http://freeworldbrand.com> | Liquidation Marketplace: <https://freeworldimports.com>

Commodities Webstore: <https://commodities.freeworldbrand.com/>

Phone/Fax: 609-318-0570 | Email: [bizdev@freeworldbrand.com](mailto:bizdev@freeworldbrand.com)



Global Traders: Operators of the Unconventional Inventory Liquidation Marketplace FreeWorldImports.com

## **FWI UNLISTED PRODUCTS | HIGHLY DISCOUNTED**

### **FWB PRODUCT -- UNRLPRD-010623-06:**

**ADULTS & KIDS WINTER WARM SKI & SNOWBOARD THERMAL SOCKS | PER 50,000 PAIRS LOT | EXW: LOS ANGELES | FWB DISCOUNTED PRICE: **\$1.50** PER PAIR**

Please [contact us](#) for additional information:



#### **BREAKDOWN**

- Adult: 30,000 Pairs | Kids: 20,000 Pairs | Mixed sizes | Mixed Colors

Currently Retail at Amazon and other for: \$16.00+ Per 3-Pairs Pack

309 Fellowship Road | East Gate Center | Suite 200 | Mt. Laurel | NJ 08054

Web-Presence: <http://freeworldbrand.com> | Liquidation Marketplace: <https://freeworldimports.com>

Commodities Webstore: <https://commodities.freeworldbrand.com/>

Phone/Fax: 609-318-0570 | Email: [bizdev@freeworldbrand.com](mailto:bizdev@freeworldbrand.com)



Global Traders: Operators of the Unconventional Inventory Liquidation Marketplace FreeWorldImports.com

## **FWI UNLISTED PRODUCTS | HIGHLY DISCOUNTED**

### **FWB PRODUCT -- UNRLPRD-010623-07:**

**PTC™ CERAMIC HEATER | PER 700 UNITS LOT | EXW: LOS ANGELES**

**FWB DISCOUNTED PRICE: \$10.50 PER UNIT**

Please [contact us](#) for additional information:



309 Fellowship Road | East Gate Center | Suite 200 | Mt. Laurel | NJ 08054

Web-Presence: <http://freeworldbrand.com> | Liquidation Marketplace: <https://freeworldimports.com>

Commodities Webstore: <https://commodities.freeworldbrand.com/>

Phone/Fax: 609-318-0570 | Email: [bizdev@freeworldbrand.com](mailto:bizdev@freeworldbrand.com)



Global Traders: Operators of the Unconventional Inventory Liquidation Marketplace FreeWorldImports.com

## **FWI UNLISTED PRODUCTS | HIGHLY DISCOUNTED**

### **FWB PRODUCT -- UNRLPRD-010623-08:**

**ROBOROCK™ S7 ROBOT VACUUM AND MOP | PER 300 UNITS LOT | EXW: LOS ANGELES  
FWB DISCOUNTED PRICE: **\$163.50** PER UNIT**

Please [contact us](#) for additional information:



#### **Sonic Mopping Technology**

3000 Vibrations per Minute, 300ml Water Tank



#### **Voice Control**

Compatible with Amazon Alexa, Google Home, and Siri Shortcuts



#### **Accurate Cleaning**

LIDAR navigation



#### **Comprehensive App Control**

- Route Tracking
- Schedule Cleaning
- No-Go Zones & Invisible Walls
- Set Clean Intensity
- Carpet Display

Currently Retail at Amazon and other for: **\$649+ Per Unit**

309 Fellowship Road | East Gate Center | Suite 200 | Mt. Laurel | NJ 08054

Web-Presence: <http://freeworldbrand.com> | Liquidation Marketplace: <https://freeworldimports.com>

Commodities Webstore: <https://commodities.freeworldbrand.com/>

Phone/Fax: 609-318-0570 | Email: [bizdev@freeworldbrand.com](mailto:bizdev@freeworldbrand.com)





Global Traders: Operators of the Unconventional Inventory Liquidation Marketplace FreeWorldImports.com

## FWI UNLISTED PRODUCTS | HIGHLY DISCOUNTED

### FWB PRODUCT -- UNRLPRD-010623-09:

OUTDOOR STAINLESS STEEL PATIO PROPANE HEATER WITH WHEELS | PER 280 UNITS LOT | EXW: LOS ANGELES | FWB DISCOUNTED PRICE: **\$40.00** PER UNIT

Please [contact us](#) for additional information:



#### BREAKDOWN - Four (4) Colors

- **Blue:** 50 Units | **Green:** 60 Units | **Grey:** 100 Units | **Ted:** 70 Units

Currently Retail at Amazon and other for: \$129+ Per Unit

309 Fellowship Road | East Gate Center | Suite 200 | Mt. Laurel | NJ 08054

Web-Presence: <http://freeworldbrand.com> | Liquidation Marketplace: <https://freeworldimports.com>

Commodities Webstore: <https://commodities.freeworldbrand.com/>

Phone/Fax: 609-318-0570 | Email: [bizdev@freeworldbrand.com](mailto:bizdev@freeworldbrand.com)



Global Traders: Operators of the Unconventional Inventory Liquidation Marketplace FreeWorldImports.com

## **FWI UNLISTED PRODUCTS | HIGHLY DISCOUNTED**

### **FWB PRODUCT -- UNRLPRD-010623-10:**

**2 GALLON PORTABLE BUCKET & CAMPING WATER JUG WITH SPOUT | PER 1,000 UNITS LOT | EXW: NEW JERSEY | FWB DISCOUNTED PRICE: \$15.00 PER UNIT**

Please [contact us](#) for additional information:



COLAPZ™ 2-in-1 Collapsible Camping Water Container with Spigot - 2 Gallon Portable Bucket & Camping Water Jug with Spout - Sports Water Jug - RV Bucket - Water Jug Dispenser - Camping Essentials

#### **BREAKDOWN**

- **Green** - 2 Gallon: 500 Units | **Blue**-1,5 Gallon: 500 Units | Total: 2 pallets

Currently Retail at Amazon and other for: \$42+ Per Unit

309 Fellowship Road | East Gate Center | Suite 200 | Mt. Laurel | NJ 08054

Web-Presence: <http://freeworldbrand.com> | Liquidation Marketplace: <https://freeworldimports.com>

Commodities Webstore: <https://commodities.freeworldbrand.com/>

Phone/Fax: 609-318-0570 | Email: [bizdev@freeworldbrand.com](mailto:bizdev@freeworldbrand.com)



Global Traders: Operators of the Unconventional Inventory Liquidation Marketplace FreeWorldImports.com

## **FWI UNLISTED PRODUCTS | HIGHLY DISCOUNTED**

### **FWB PRODUCT -- UNRLPRD-010623-11:**

**HISENSE 58-INCH ULED U6 SERIES QUANTUM SMART FIRE TV | PER 216 UNITS LOT | EXW: LOS ANGELES | FWB DISCOUNTED PRICE: **\$235.00** PER UNIT**

Please [contact us](#) for additional information:



#### **All-in-One Entertainment**

With Fire TV built-in, you can enjoy a world of entertainment from subscriptions to Prime Video, Netflix, Disney+, Hulu, and HBO Max.



Currently Retail at Amazon and other for: \$349+ Per Unit

309 Fellowship Road | East Gate Center | Suite 200 | Mt. Laurel | NJ 08054

Web-Presence: <http://freeworldbrand.com> | Liquidation Marketplace: <https://freeworldimports.com>

Commodities Webstore: <https://commodities.freeworldbrand.com/>

Phone/Fax: 609-318-0570 | Email: [bizdev@freeworldbrand.com](mailto:bizdev@freeworldbrand.com)



Global Traders: Operators of the Unconventional Inventory Liquidation Marketplace FreeWorldImports.com

## **FWI UNLISTED PRODUCTS | HIGHLY DISCOUNTED**

### **FWB PRODUCT -- UNRLPRD-010623-12:**

**STEVE MADDEN™ WOMEN'S SNEAKERS & DRESS SHOES | PER 3,100 PAIRS LOT | EXW: LOS ANGELES | FWB DISCOUNTED PRICE: **\$14.00** PER PAIR**

Please [contact us](#) for additional information:



All Sneakers are new in boxes and mixed in styles and sizes with UPC number | No detail manifest is available.

#### **BREAKDOWN:**

- **SNEAKERS:** 1,700 Pairs | **DRESS SHOES:** 1,400 Pairs

309 Fellowship Road | East Gate Center | Suite 200 | Mt. Laurel | NJ 08054

Web-Presence: <http://freeworldbrand.com> | Liquidation Marketplace: <https://freeworldimports.com>

Commodities Webstore: <https://commodities.freeworldbrand.com/>

Phone/Fax: 609-318-0570 | Email: [bizdev@freeworldbrand.com](mailto:bizdev@freeworldbrand.com)



Global Traders: Operators of the Unconventional Inventory Liquidation Marketplace FreeWorldImports.com

---

## **FWI UNLISTED PRODUCTS | HIGHLY DISCOUNTED**

---

### **FWB PRODUCT -- UNRLPRD-010623-13:**

**SAUCONY™ MEN'S & WOMEN'S RUNNING SHOES | PER 4,000 PAIRS LOT | EXW: LOS ANGELES | FWB DISCOUNTED PRICE: **\$25.85** PER PAIR**

Please [contact us](#) for additional information:



All Sneakers are new in boxes | Mixed styles and sizes with UPC

#### **BREAKDOWN**

- **MEN'S:** 2,000 Pairs (Sizes: 7.5 -13) | **WOMEN'S:** 2,000 Pairs (Sizes: 6- 11)

---

309 Fellowship Road | East Gate Center | Suite 200 | Mt. Laurel | NJ 08054

Web-Presence: <http://freeworldbrand.com> | Liquidation Marketplace: <https://freeworldimports.com>

Commodities Webstore: <https://commodities.freeworldbrand.com/>

Phone/Fax: 609-318-0570 | Email: [bizdev@freeworldbrand.com](mailto:bizdev@freeworldbrand.com)



Global Traders: Operators of the Unconventional Inventory Liquidation Marketplace FreeWorldImports.com

---

## **FWI UNLISTED PRODUCTS | HIGHLY DISCOUNTED**

---

### **FWB PRODUCT -- UNRLPRD-010623-14:**

**ASICS™ MEN'S & WOMEN'S RUNNING SHOES | PER 2,400 PAIRS LOT | EXW: LOS ANGELES |  
FWB DISCOUNTED PRICE: **\$27.00** PER PAIR**

Please [contact us](#) for additional information:



All Sneakers are new in boxes | Mixed styles and sizes with UPC

#### **BREAKDOWN**

- **MEN'S:** 1,200 Pairs (Sizes: 7.5 -13) | **WOMEN'S:** 1,200 Pairs (Sizes: 6- 11)

---

309 Fellowship Road | East Gate Center | Suite 200 | Mt. Laurel | NJ 08054

Web-Presence: <http://freeworldbrand.com> | Liquidation Marketplace: <https://freeworldimports.com>

Commodities Webstore: <https://commodities.freeworldbrand.com/>

Phone/Fax: 609-318-0570 | Email: [bizdev@freeworldbrand.com](mailto:bizdev@freeworldbrand.com)



Global Traders: Operators of the Unconventional Inventory Liquidation Marketplace FreeWorldImports.com

## **FWI UNLISTED PRODUCTS | HIGHLY DISCOUNTED**

### **FWB PRODUCT -- UNRLPRD-010623-15:**

**PHILIPS™ SPP3201WA/37 3-OUTLET GROUNDED CUBE TAP 2 USB PORTS 2.4A | PER 8,729 UNITS LOT | EXW: CHICAGO | FWB DISCOUNTED PRICE: **\$4.50** PER UNIT**

Please [contact us](#) for additional information:



**FEATURES:** Two (2) USB Charging Ports | Three (3) Grounded Outlets to power all your devices

309 Fellowship Road | East Gate Center | Suite 200 | Mt. Laurel | NJ 08054

Web-Presence: <http://freeworldbrand.com> | Liquidation Marketplace: <https://freeworldimports.com>

Commodities Webstore: <https://commodities.freeworldbrand.com/>

Phone/Fax: 609-318-0570 | Email: [bizdev@freeworldbrand.com](mailto:bizdev@freeworldbrand.com)



Global Traders: Operators of the Unconventional Inventory Liquidation Marketplace FreeWorldImports.com

## **FWI UNLISTED PRODUCTS | HIGHLY DISCOUNTED**

### **FWB PRODUCT -- UNRLPRD-010623-16:**

**GE™ 3-OUTLET GROUNDED TAP EASY ACCESS GRAY | PER 6,505 UNITS LOT | EXW: CHICAGO | FWB DISCOUNTED PRICE: **\$4.50** PER UNIT**

Please [contact us](#) for additional information:



**FEATURES:** Grounded 3-Outlet Tap | Converts one grounded indoor wall outlet into three

309 Fellowship Road | East Gate Center | Suite 200 | Mt. Laurel | NJ 08054

Web-Presence: <http://freeworldbrand.com> | Liquidation Marketplace: <https://freeworldimports.com>

Commodities Webstore: <https://commodities.freeworldbrand.com/>

Phone/Fax: 609-318-0570 | Email: [bizdev@freeworldbrand.com](mailto:bizdev@freeworldbrand.com)





Global Traders: Operators of the Unconventional Inventory Liquidation Marketplace FreeWorldImports.com

## **FWI UNLISTED PRODUCTS | HIGHLY DISCOUNTED**

### **FWB PRODUCT -- UNRLPRD-010623-17:**

**PHILIPS™ 6 OUTLET TAP ADAPTER SPACED OUTLETS WHITE 2PK, “BROWN BOX WITH PICTURE AND UPC CODE” | PER 4,505 UNITS LOT | EXW: CHICAGO | FWB DISCOUNTED PRICE: **\$7.00** PER UNIT**

Please [contact us](#) for additional information:



**UPC: 030878474283**

- **Power More** – This versatile wall adapter tap expands 2 grounded outlets into 6, to power iPhone or Android smartphones, lamps, laptops, hair dryers or other electronics
- **Space-Saving Design** – Slim, 3-sided design allows furniture to sit closer to the wall while 4 side-access outlets provide easy connections in tight spaces

309 Fellowship Road | East Gate Center | Suite 200 | Mt. Laurel | NJ 08054

Web-Presence: <http://freeworldbrand.com> | Liquidation Marketplace: <https://freeworldimports.com>

Commodities Webstore: <https://commodities.freeworldbrand.com/>

Phone/Fax: 609-318-0570 | Email: [bizdev@freeworldbrand.com](mailto:bizdev@freeworldbrand.com)



Global Traders: Operators of the Unconventional Inventory Liquidation Marketplace FreeWorldImports.com

---

## FWI UNLISTED PRODUCTS | **HIGHLY DISCOUNTED**

---

- **Compatibility** – This Philips wall plug works with your existing grounded 3-prong 2-outlet duplex receptacle to create a centralized charging station in your home office, bedroom, kitchen, living room or any area with limited outlets
- **Discreet Appearance** – The tap completely covers your existing wall-plate for a seamless look, and the white finish easily integrates into any décor
- **Adapter-Spaced Outlets** – This outlet tap has three standard outlets and three extra-wide spaced outlets to fit those bulky cell phone chargers or power adapters

### **FWB PRODUCT -- UNRLPRD-010623-18:**

**XTREME SPORT™ 20 PACKS LADIES NO SHOW SOCKS IN BLACK SIZE 9-11 | PER 18,000 PACKS OF 20 SOCKS LOT | EXW: LOS ANGELES**

**FWB DISCOUNTED PRICE: **\$6.00** PER PACK OF 20 SOCKS**

Please [contact us](#) for additional information:



---

309 Fellowship Road | East Gate Center | Suite 200 | Mt. Laurel | NJ 08054

Web-Presence: <http://freeworldbrand.com> | Liquidation Marketplace: <https://freeworldimports.com>

Commodities Webstore: <https://commodities.freeworldbrand.com/>

Phone/Fax: 609-318-0570 | Email: [bizdev@freeworldbrand.com](mailto:bizdev@freeworldbrand.com)



Global Traders: Operators of the Unconventional Inventory Liquidation Marketplace FreeWorldImports.com

---

## **FWI UNLISTED PRODUCTS | HIGHLY DISCOUNTED**

---

### **FWB PRODUCT -- UNRLPRD-010623-19:**

**SHEFIT™ LADIES ACTIVEWEAR | PER 132,127 PIECES LOT | EXW: EAST COAST, USA**

**FWB DISCOUNTED PRICE: \$2.00 PER PIECE**

Please [contact us](#) for additional information:



### **FWB PRODUCT -- UNRLPRD-120122-03 :**

**MY CLIK™ RING BLUETOOTH SELFIE/VIDEO REMOTE WITH TRIPOD | PER 43,584 UNITS LOT | EXW: MIAMI, FL**

**FWB DISCOUNTED PRICE: \$2.00 PER UNIT**

Please [contact us](#) for additional information:



---

309 Fellowship Road | East Gate Center | Suite 200 | Mt. Laurel | NJ 08054

Web-Presence: <http://freeworldbrand.com> | Liquidation Marketplace: <https://freeworldimports.com>

Commodities Webstore: <https://commodities.freeworldbrand.com/>

Phone/Fax: 609-318-0570 | Email: [bizdev@freeworldbrand.com](mailto:bizdev@freeworldbrand.com)



Global Traders: Operators of the Unconventional Inventory Liquidation Marketplace FreeWorldImports.com

## **FWI UNLISTED PRODUCTS | HIGHLY DISCOUNTED**

### **FWB PRODUCT -- UNRLPRD-010623-20:**

**MASSAGE RECLINER CHAIR 360 DEGREE SWIVEL SINGLE SOFA ROCKER W/HEATING | PER 1,000 UNITS LOT | EXW: LOS ANGELES**

**FWB DISCOUNTED PRICE: \$105.00 PER UNIT**

Please [contact us](#) for additional information:



#### Reclining Design for Different Occasions



Read



Watch TV



Take a Nap



**RETAIL: \$468.95**

**See: [GYMAX MASSAGE RECLINER CHAIR 360 DEGREE SWIVEL SINGLE SOFA ROCKER W/HEATING GYM09359 - THE HOME DEPOT](#)**

309 Fellowship Road | East Gate Center | Suite 200 | Mt. Laurel | NJ 08054

Web-Presence: <http://freeworldbrand.com> | Liquidation Marketplace: <https://freeworldimports.com>

Commodities Webstore: <https://commodities.freeworldbrand.com/>

Phone/Fax: 609-318-0570 | Email: [bizdev@freeworldbrand.com](mailto:bizdev@freeworldbrand.com)



Global Traders: Operators of the Unconventional Inventory Liquidation Marketplace FreeWorldImports.com

---

## **FWI UNLISTED PRODUCTS | HIGHLY DISCOUNTED**

---

### **FWB PRODUCT -- UNRLPRD-010623-21:**

**FLOYD ROSE™ DUAL DRIVER BLUETOOTH EARBUD WITH 3D SOUND TECHNOLOGY | PER 600 UNITS LOT | EXW: LOS ANGELES**

**FWB DISCOUNTED PRICE: \$4.50 PER UNIT**

Please [contact us](#) for additional information:



*Floyd Rose*<sup>®</sup>  
AUDIO COLLECTION

---

309 Fellowship Road | East Gate Center | Suite 200 | Mt. Laurel | NJ 08054

Web-Presence: <http://freeworldbrand.com> | Liquidation Marketplace: <https://freeworldimports.com>

Commodities Webstore: <https://commodities.freeworldbrand.com/>

Phone/Fax: 609-318-0570 | Email: [bizdev@freeworldbrand.com](mailto:bizdev@freeworldbrand.com)



Global Traders: Operators of the Unconventional Inventory Liquidation Marketplace FreeWorldImports.com

---

## **FWI UNLISTED PRODUCTS | HIGHLY DISCOUNTED**

---

### **FWB PRODUCT -- UNRLPRD-010623-22:**

**SBOLY™ 7 BLADES IN 1 VEGETABLE SPIRALIZER | PER 1,050 UNITS LOT | EXW: LOS ANGELES**

**FWB DISCOUNTED PRICE: \$7.00 PER UNIT**

*Please [contact us](#) for additional information:*



---

309 Fellowship Road | East Gate Center | Suite 200 | Mt. Laurel | NJ 08054

**Web-Presence:** <http://freeworldbrand.com> | **Liquidation Marketplace:** <https://freeworldimports.com>

Commodities Webstore: <https://commodities.freeworldbrand.com/>

**Phone/Fax:** 609-318-0570 | **Email:** [bizdev@freeworldbrand.com](mailto:bizdev@freeworldbrand.com)



Global Traders: Operators of the Unconventional Inventory Liquidation Marketplace FreeWorldImports.com

## **FWI UNLISTED PRODUCTS | HIGHLY DISCOUNTED**

### **FWB PRODUCT -- UNRLPRD-010623-23:**

**ARCHSTONE™ ELECTRIC TOOTHBRUSH - 3 BRUSH HEADS, RECHARGEABLE BATTERY, USB PLUG | PER 2,000 UNITS LOT | EXW: LOS ANGELES**

**FWB DISCOUNTED PRICE: \$7.00 PER UNIT**

Please [contact us](#) for additional information:



309 Fellowship Road | East Gate Center | Suite 200 | Mt. Laurel | NJ 08054

Web-Presence: <http://freeworldbrand.com> | Liquidation Marketplace: <https://freeworldimports.com>

Commodities Webstore: <https://commodities.freeworldbrand.com/>

Phone/Fax: 609-318-0570 | Email: [bizdev@freeworldbrand.com](mailto:bizdev@freeworldbrand.com)



Global Traders: Operators of the Unconventional Inventory Liquidation Marketplace FreeWorldImports.com

---

## **FWI UNLISTED PRODUCTS | HIGHLY DISCOUNTED**

---

### **FWB PRODUCT -- UNRLPRD-010623-24:**

**HAUSWIRT™ SMOOTHIE BLENDER | PER 500 UNITS LOT | EXW: INDIANA**

**FWB DISCOUNTED PRICE: \$ 33.50 PER UNIT**

*Please [contact us](#) for additional information:*



---

309 Fellowship Road | East Gate Center | Suite 200 | Mt. Laurel | NJ 08054

**Web-Presence:** <http://freeworldbrand.com> | **Liquidation Marketplace:** <https://freeworldimports.com>

Commodities Webstore: <https://commodities.freeworldbrand.com/>

**Phone/Fax:** 609-318-0570 | **Email:** [bizdev@freeworldbrand.com](mailto:bizdev@freeworldbrand.com)





Global Traders: Operators of the Unconventional Inventory Liquidation Marketplace FreeWorldImports.com

---

## **FWI UNLISTED PRODUCTS | HIGHLY DISCOUNTED**

---

### **FWB PRODUCT -- UNRLPRD-010623-25:**

**PERSONAL CHILLER™ SOFT NUGGET ICE MAKER | PER 170 UNITS LOT | EXW: LOS ANGELES**

**FWB DISCOUNTED PRICE: \$ 46.50 PER UNIT**

Please [contact us](#) for additional information:



---

309 Fellowship Road | East Gate Center | Suite 200 | Mt. Laurel | NJ 08054

Web-Presence: <http://freeworldbrand.com> | Liquidation Marketplace: <https://freeworldimports.com>

Commodities Webstore: <https://commodities.freeworldbrand.com/>

Phone/Fax: 609-318-0570 | Email: [bizdev@freeworldbrand.com](mailto:bizdev@freeworldbrand.com)



Global Traders: Operators of the Unconventional Inventory Liquidation Marketplace FreeWorldImports.com

---

## **FWI UNLISTED PRODUCTS | HIGHLY DISCOUNTED**

---

### **FWB PRODUCT -- UNRLPRD-010623-26:**

**TANGO POPS™ 4 FLAVORS LOLLIPOPS WITH BUBBLE GUM CENTER | PER 18,360 BOXES LOT | EXW: DALLAS**

**FWB DISCOUNTED PRICE: \$ 3.00 PER BOX OF 50 LOLLIPOPS**

*Please [contact us](#) for additional information:*



---

309 Fellowship Road | East Gate Center | Suite 200 | Mt. Laurel | NJ 08054

Web-Presence: <http://freeworldbrand.com> | Liquidation Marketplace: <https://freeworldimports.com>

Commodities Webstore: <https://commodities.freeworldbrand.com/>

Phone/Fax: 609-318-0570 | Email: [bizdev@freeworldbrand.com](mailto:bizdev@freeworldbrand.com)



Global Traders: Operators of the Unconventional Inventory Liquidation Marketplace FreeWorldImports.com

---

## **FWI UNLISTED PRODUCTS | HIGHLY DISCOUNTED**

---

### **FWB PRODUCT -- UNRLPRD-010623-27:**

**VENIGO™ 10X MAGNIFYING LIGHTED MAKEUP MIRROR WITH TOUCH CONTROL LED LIGHTS  
| PER 864 UNITS LOT | EXW: LOS ANGELES**

**FWB DISCOUNTED PRICE: \$ 4.50 PER UNIT**

Please [contact us](#) for additional information:



---

309 Fellowship Road | East Gate Center | Suite 200 | Mt. Laurel | NJ 08054

Web-Presence: <http://freeworldbrand.com> | Liquidation Marketplace: <https://freeworldimports.com>

Commodities Webstore: <https://commodities.freeworldbrand.com/>

Phone/Fax: 609-318-0570 | Email: [bizdev@freeworldbrand.com](mailto:bizdev@freeworldbrand.com)



Global Traders: Operators of the Unconventional Inventory Liquidation Marketplace FreeWorldImports.com

---

## **FWI UNLISTED PRODUCTS | HIGHLY DISCOUNTED**

---

### **FWB PRODUCT -- UNRLPRD-010623-28:**

**FIRMINATOR™ PETS FLEA & TICK FINDER | PER 11,083 UNITS LOT | EXW: LOS ANGELES**

**FWB DISCOUNTED PRICE: \$ 3.95 PER UNIT**

*Please [contact us](#) for additional information:*



---

309 Fellowship Road | East Gate Center | Suite 200 | Mt. Laurel | NJ 08054

Web-Presence: <http://freeworldbrand.com> | Liquidation Marketplace: <https://freeworldimports.com>

Commodities Webstore: <https://commodities.freeworldbrand.com/>

Phone/Fax: 609-318-0570 | Email: [bizdev@freeworldbrand.com](mailto:bizdev@freeworldbrand.com)



Global Traders: Operators of the Unconventional Inventory Liquidation Marketplace FreeWorldImports.com

---

## **FWI UNLISTED PRODUCTS | HIGHLY DISCOUNTED**

---

### **FWB PRODUCT -- UNRLPRD-010623-28:**

**PUMA™ JACKETS | PER 62,048 UNITS LOT | EXW: TEXAS**

**FWB DISCOUNTED PRICE: \$ 13.50 PER UNIT**

*Please [contact us](#) for additional information:*



---

309 Fellowship Road | East Gate Center | Suite 200 | Mt. Laurel | NJ 08054

**Web-Presence:** <http://freeworldbrand.com> | **Liquidation Marketplace:** <https://freeworldimports.com>

Commodities Webstore: <https://commodities.freeworldbrand.com/>

**Phone/Fax:** 609-318-0570 | **Email:** bizdev@freeworldbrand.com



Global Traders: Operators of the Unconventional Inventory Liquidation Marketplace FreeWorldImports.com

---

## **FWI UNLISTED PRODUCTS | HIGHLY DISCOUNTED**

---

### **FWB PRODUCT -- UNRLPRD-010623-29:**

**DASH™ SHAVED ICE MAKER + SLUSHIE MACHINE | PER 2,000 UNITS LOT | EXW: LOS ANGELES**

**FWB DISCOUNTED PRICE: \$ 14.50 PER UNIT**

Please [contact us](#) for additional information:



---

309 Fellowship Road | East Gate Center | Suite 200 | Mt. Laurel | NJ 08054

**Web-Presence:** <http://freeworldbrand.com> | **Liquidation Marketplace:** <https://freeworldimports.com>

Commodities Webstore: <https://commodities.freeworldbrand.com/>

**Phone/Fax:** 609-318-0570 | **Email:** bizdev@freeworldbrand.com



Global Traders: Operators of the Unconventional Inventory Liquidation Marketplace FreeWorldImports.com

---

## **FWI UNLISTED PRODUCTS | HIGHLY DISCOUNTED**

---

### **FWB PRODUCT -- UNRLPRD-010623-30:**

**NESTLE™ OPTIFAST 8OZ PROTEIN SHAKES | PER 2,500 (24 UNITS) CASES LOT | EXW: LOS ANGELES**

**FWB DISCOUNTED PRICE: \$ 6.50 PER CASE**

Please [contact us](#) for additional information:



---

309 Fellowship Road | East Gate Center | Suite 200 | Mt. Laurel | NJ 08054

Web-Presence: <http://freeworldbrand.com> | Liquidation Marketplace: <https://freeworldimports.com>

Commodities Webstore: <https://commodities.freeworldbrand.com/>

Phone/Fax: 609-318-0570 | Email: [bizdev@freeworldbrand.com](mailto:bizdev@freeworldbrand.com)



Global Traders: Operators of the Unconventional Inventory Liquidation Marketplace FreeWorldImports.com

## FWI UNLISTED PRODUCTS | **HIGHLY DISCOUNTED**

### FWB PRODUCT -- UNRLPRD-010623-31:

RECHARGEABLE EAR AND NOSE HAIR TRIMMER | PER 2,300 UNITS LOT | EXW: LOS ANGELES

FWB DISCOUNTED PRICE: **\$5.00** PER UNIT

Please [contact us](#) for additional information:



309 Fellowship Road | East Gate Center | Suite 200 | Mt. Laurel | NJ 08054

Web-Presence: <http://freeworldbrand.com> | Liquidation Marketplace: <https://freeworldimports.com>

Commodities Webstore: <https://commodities.freeworldbrand.com/>

Phone/Fax: 609-318-0570 | Email: [bizdev@freeworldbrand.com](mailto:bizdev@freeworldbrand.com)





Global Traders: Operators of the Unconventional Inventory Liquidation Marketplace FreeWorldImports.com

---

## **FWI UNLISTED PRODUCTS | HIGHLY DISCOUNTED**

---

### **FWB PRODUCT -- UNRLPRD-010623-32:**

**ROOMIE™ TEC SOPHIE SMART BODY SCALE WITH FREE APP | PER 2,500 UNITS LOT | EXW: LOS ANGELES**

**FWB DISCOUNTED PRICE: \$8.00 PER UNIT**

Please [contact us](#) for additional information:



---

309 Fellowship Road | East Gate Center | Suite 200 | Mt. Laurel | NJ 08054

**Web-Presence:** <http://freeworldbrand.com> | **Liquidation Marketplace:** <https://freeworldimports.com>

Commodities Webstore: <https://commodities.freeworldbrand.com/>

**Phone/Fax:** 609-318-0570 | **Email:** bizdev@freeworldbrand.com



Global Traders: Operators of the Unconventional Inventory Liquidation Marketplace FreeWorldImports.com

## FWI UNLISTED PRODUCTS | HIGHLY DISCOUNTED

### FWB PRODUCT -- UNRLPRD-010623-33:

LEVOIT™ OASIS MIST SMART COOL AND WARM MIST HUMIDIFIERS | PER 1,200 UNITS LOT | EXW: LOS ANGELES

FWB DISCOUNTED PRICE: **\$33.00** PER UNIT

Please [contact us](#) for additional information:



### FWB PRODUCT -- UNRLPRD-010623-34:

FILA™ MEN'S & WOMEN'S HASH CLOSEOUT | PER 11,329 PAIRS LOT | EXW: BALTIMORE

FWB DISCOUNTED PRICE: **\$ 14.00** PER PAIR

Please [contact us](#) for additional information:



309 Fellowship Road | East Gate Center | Suite 200 | Mt. Laurel | NJ 08054

Web-Presence: <http://freeworldbrand.com> | Liquidation Marketplace: <https://freeworldimports.com>

Commodities Webstore: <https://commodities.freeworldbrand.com/>

Phone/Fax: 609-318-0570 | Email: [bizdev@freeworldbrand.com](mailto:bizdev@freeworldbrand.com)



Global Traders: Operators of the Unconventional Inventory Liquidation Marketplace FreeWorldImports.com

## **FWI UNLISTED PRODUCTS | HIGHLY DISCOUNTED**

### **FWB PRODUCT -- UNRLPRD-010623-35:**

**DASH™ 8" EXPRESS ELECTRIC ROUND GRIDDLE | PER 736 UNITS LOT | EXW: LOS ANGELES**

**FWB DISCOUNTED PRICE: \$ 8.00 PER UNIT**

Please [contact us](#) for additional information:



### **FWB PRODUCT -- UNRLPRD-120422-06 :**

**DASH™ MINI RICE COOKER STEAMER WITH REMOVABLE NONSTICK POT | PER 1,008 UNITS LOT | EXW: LOS ANGELES**

**FWB DISCOUNTED PRICE: \$ 11.00 PER UNIT**

Please [contact us](#) for additional information:



**all-in-one  
VERSATILITY**



rice bowls



soups



quinoa



and more!

**2 CUP  
CAPACITY**

Mixing paddle Measuring cup



309 Fellowship Road | East Gate Center | Suite 200 | Mt. Laurel | NJ 08054

Web-Presence: <http://freeworldbrand.com> | Liquidation Marketplace: <https://freeworldimports.com>

Commodities Webstore: <https://commodities.freeworldbrand.com/>

Phone/Fax: 609-318-0570 | Email: [bizdev@freeworldbrand.com](mailto:bizdev@freeworldbrand.com)



Global Traders: Operators of the Unconventional Inventory Liquidation Marketplace FreeWorldImports.com

# FWI UNLISTED PRODUCTS | HIGHLY DISCOUNTED

## FWB PRODUCT -- UNRLPRD-010623-36:

LOFTER™ PRIME RATED BAGEL TOASTERS WITH LCD DISPLAY | PER 2,000 UNITS LOT | EXW: CHICAGO

FWB DISCOUNTED PRICE: **\$11.00** PER UNIT

Please [contact us](#) for additional information:



### FRESHLY BAKED BAGELS

7 browning settings at your choice and you can also switch to bagel mode during the normal baking process



Step 1: Press "Bagel" button.  
Step 2: Rotate shade selector.

### FOUR FUNCTION KEYS

Bagel toasts the cut side of bagel, Reheat heat 30 secs on selected gear, defrost setting for defrosting bread, Cancel can ends toasting anytime.



Sandwich



Bread Pudding



Toast Salad

- DEFROST** Plus about 12% time base on gear time
- REAL BAGEL** The Bagel function toasts the cut side of bagel, doughnut, etc
- CANCEL** Stop toasting anytime
- REHEAT** Reheat bread again (about 30s)



LCD Screen Shows Remaining Time



7-Setting Shade Knob/Reheat Function



### 7-SETTING BAKING GEAR MEETS YOUR NEEDS



- 1 for Light
- 2 for Light
- 3 for Golden
- 4 for Golden
- 5 for Golden
- 6 for Dark
- 7 for Dark

309 Fellowship Road | East Gate Center | Suite 200 | Mt. Laurel | NJ 08054

Web-Presence: <http://freeworldbrand.com> | Liquidation Marketplace: <https://freeworldimports.com>

Commodities Webstore: <https://commodities.freeworldbrand.com/>

Phone/Fax: 609-318-0570 | Email: [bizdev@freeworldbrand.com](mailto:bizdev@freeworldbrand.com)



Global Traders: Operators of the Unconventional Inventory Liquidation Marketplace FreeWorldImports.com

## **FWI UNLISTED PRODUCTS | HIGHLY DISCOUNTED**

### **FWB PRODUCT -- UNRLPRD-010623-37:**

**PASER™ MOTIVATIONAL WATER BOTTLE | PER 24,203 UNITS LOT | EXW: LOS ANGELES**

**FWB DISCOUNTED PRICE: \$ 4.00 PER UNIT**

Please [contact us](#) for additional information:



309 Fellowship Road | East Gate Center | Suite 200 | Mt. Laurel | NJ 08054

Web-Presence: <http://freeworldbrand.com> | Liquidation Marketplace: <https://freeworldimports.com>

Commodities Webstore: <https://commodities.freeworldbrand.com/>

Phone/Fax: 609-318-0570 | Email: [bizdev@freeworldbrand.com](mailto:bizdev@freeworldbrand.com)



Global Traders: Operators of the Unconventional Inventory Liquidation Marketplace FreeWorldImports.com

---

## **FWI UNLISTED PRODUCTS | HIGHLY DISCOUNTED**

---

### **FWB PRODUCT -- UNRLPRD-010623-38:**

**BRANDED MEN'S ASSORTED DRESS PANTS | PER 40,000 PAIRS LOT | EXW: LOS ANGELES**

**FWB DISCOUNTED PRICE: \$3.00 PER PAIR**

*Please [contact us](#) for additional information:*



---

309 Fellowship Road | East Gate Center | Suite 200 | Mt. Laurel | NJ 08054

**Web-Presence:** <http://freeworldbrand.com> | **Liquidation Marketplace:** <https://freeworldimports.com>

Commodities Webstore: <https://commodities.freeworldbrand.com/>

**Phone/Fax:** 609-318-0570 | **Email:** bizdev@freeworldbrand.com



Global Traders: Operators of the Unconventional Inventory Liquidation Marketplace FreeWorldImports.com

## **FWI UNLISTED PRODUCTS | HIGHLY DISCOUNTED**

### **FWB PRODUCT -- UNRLPRD-010623-39:**

**PAW PATROL™ & DISNEY™ 15" FLY WHEEL JUNIOR CRUISER | PER 400 UNITS LOT | EXW: LOS ANGELES | FWB DISCOUNTED PRICE: \$35.00 PER UNIT**

Please [contact us](#) for additional information:



309 Fellowship Road | East Gate Center | Suite 200 | Mt. Laurel | NJ 08054

Web-Presence: <http://freeworldbrand.com> | Liquidation Marketplace: <https://freeworldimports.com>

Commodities Webstore: <https://commodities.freeworldbrand.com/>

Phone/Fax: 609-318-0570 | Email: [bizdev@freeworldbrand.com](mailto:bizdev@freeworldbrand.com)



Global Traders: Operators of the Unconventional Inventory Liquidation Marketplace FreeWorldImports.com

## **FWI UNLISTED PRODUCTS | HIGHLY DISCOUNTED**

### **FWB PRODUCT -- UNRLPRD-010623-40:**

**SOLID GOLD INDIGO MOON – (12 LBS) - DRY CAT FOOD | PER 700 BAGS LOT | EXW: LOS ANGELES | FWB DISCOUNTED PRICE: \$18.00 PER BAG**

Please [contact us](#) for additional information:



309 Fellowship Road | East Gate Center | Suite 200 | Mt. Laurel | NJ 08054

Web-Presence: <http://freeworldbrand.com> | Liquidation Marketplace: <https://freeworldimports.com>

Commodities Webstore: <https://commodities.freeworldbrand.com/>

Phone/Fax: 609-318-0570 | Email: [bizdev@freeworldbrand.com](mailto:bizdev@freeworldbrand.com)





Global Traders: Operators of the Unconventional Inventory Liquidation Marketplace FreeWorldImports.com

## **FWI UNLISTED PRODUCTS | HIGHLY DISCOUNTED**

### **FWB PRODUCT -- UNRLPRD-010623-41:**

**ASUS™ 28 INCHES HDMI ADAPTIVE EYE CARE GAMING MONITOR | PER 1,000 UNITS LOT | EXW: LOS ANGELES | FWB DISCOUNTED PRICE: \$175.00 PER UNIT**

Please [contact us](#) for additional information:



ASUS-exclusive GamePlus Technology



Marathon Ready



4K UHD for Sharp, Crisp Visuals



Robust Connectivity



309 Fellowship Road | East Gate Center | Suite 200 | Mt. Laurel | NJ 08054

Web-Presence: <http://freeworldbrand.com> | Liquidation Marketplace: <https://freeworldimports.com>

Commodities Webstore: <https://commodities.freeworldbrand.com/>

Phone/Fax: 609-318-0570 | Email: [bizdev@freeworldbrand.com](mailto:bizdev@freeworldbrand.com)



Global Traders: Operators of the Unconventional Inventory Liquidation Marketplace [FreeWorldImports.com](http://FreeWorldImports.com)

## **FWI UNLISTED PRODUCTS | HIGHLY DISCOUNTED**

### **FWB PRODUCT -- UNRLPRD-010623-42:**

**CROCK-POT™ SCCPVL600-S CROCKPOT, 6 QT, STAINLESS | PER 2,000 UNITS LOT | EXW: LOS ANGELES | FWB DISCOUNTED PRICE: **\$32.50** PER UNIT**

Please [contact us](#) for additional information:



#### **Secure-Fit Lid**

Locking lid with rubber gasket for extra seal



309 Fellowship Road | East Gate Center | Suite 200 | Mt. Laurel | NJ 08054

Web-Presence: <http://freeworldbrand.com> | Liquidation Marketplace: <https://freeworldimports.com>

Commodities Webstore: <https://commodities.freeworldbrand.com/>

Phone/Fax: 609-318-0570 | Email: [bizdev@freeworldbrand.com](mailto:bizdev@freeworldbrand.com)



Global Traders: Operators of the Unconventional Inventory Liquidation Marketplace FreeWorldImports.com

---

## **FWI UNLISTED PRODUCTS | HIGHLY DISCOUNTED**

---

### **FWB PRODUCT -- UNRLPRD-010623-43:**

**HERSHEY'S CHOCOLATE CANDY BARS, 36 COUNT | PER 384 CASES LOT | EXW: NEW YORK**

**FWB DISCOUNTED PRICE: \$14.33 PER BOX OF 36 BARS**

Please [contact us](#) for additional information:



---

309 Fellowship Road | East Gate Center | Suite 200 | Mt. Laurel | NJ 08054

Web-Presence: <http://freeworldbrand.com> | Liquidation Marketplace: <https://freeworldimports.com>

Commodities Webstore: <https://commodities.freeworldbrand.com/>

Phone/Fax: 609-318-0570 | Email: [bizdev@freeworldbrand.com](mailto:bizdev@freeworldbrand.com)



Global Traders: Operators of the Unconventional Inventory Liquidation Marketplace FreeWorldImports.com

---

## FWI UNLISTED PRODUCTS | **HIGHLY DISCOUNTED**

---

### **FWB PRODUCT -- UNRLPRD-010623-44:**

**MONSTER™ LED DUAL GAMING SPEAKERS SET | PER 3,200 SETS LOT | EXW: LOS ANGELES**

**FWB DISCOUNTED PRICE: **\$8.50** PER SET**

Please [contact us](#) for additional information:

# **MONSTER®**

## LED DUAL GAMING SPEAKERS



DUAL SPEAKER SET  
WITH LED LIGHTS,  
USB POWERED.  
EACH MEASURES  
3.75" WIDE X 3.03"  
DEEP X 6.85" TALL



NEW, FACTORY FRESH, CASE PACKAGED IN 12'S.

---

309 Fellowship Road | East Gate Center | Suite 200 | Mt. Laurel | NJ 08054

Web-Presence: <http://freeworldbrand.com> | Liquidation Marketplace: <https://freeworldimports.com>

Commodities Webstore: <https://commodities.freeworldbrand.com/>

Phone/Fax: 609-318-0570 | Email: [bizdev@freeworldbrand.com](mailto:bizdev@freeworldbrand.com)



Global Traders: Operators of the Unconventional Inventory Liquidation Marketplace FreeWorldImports.com

## **FWI UNLISTED PRODUCTS | HIGHLY DISCOUNTED**

### **FWB PRODUCT -- UNRLPRD-010623-45:**

**M4™ SMART BAND 4 FITNESS TRACKER WATCH | PER 25,000 UNITS LOT | EXW: LOS ANGELES | FWB DISCOUNTED PRICE: **\$3.50** PER UNIT**

Please [contact us](#) for additional information:



**IP67 Water Resistant**



309 Fellowship Road | East Gate Center | Suite 200 | Mt. Laurel | NJ 08054

Web-Presence: <http://freeworldbrand.com> | Liquidation Marketplace: <https://freeworldimports.com>

Commodities Webstore: <https://commodities.freeworldbrand.com/>

Phone/Fax: 609-318-0570 | Email: [bizdev@freeworldbrand.com](mailto:bizdev@freeworldbrand.com)



Global Traders: Operators of the Unconventional Inventory Liquidation Marketplace FreeWorldImports.com

## **FWI UNLISTED PRODUCTS | HIGHLY DISCOUNTED**

### **FWB PRODUCT -- UNRLPRD-010623-46:**

**DOUBLE-H™ MEN'S BOOTS | PER 2,000 PAIRS LOT | EXW: LOS ANGELES | FWB DISCOUNTED PRICE: **\$50.00** PER PAIR**

Please [contact us](#) for additional information:



309 Fellowship Road | East Gate Center | Suite 200 | Mt. Laurel | NJ 08054

Web-Presence: <http://freeworldbrand.com> | Liquidation Marketplace: <https://freeworldimports.com>

Commodities Webstore: <https://commodities.freeworldbrand.com/>

Phone/Fax: 609-318-0570 | Email: [bizdev@freeworldbrand.com](mailto:bizdev@freeworldbrand.com)



Global Traders: Operators of the Unconventional Inventory Liquidation Marketplace FreeWorldImports.com

## **FWI UNLISTED PRODUCTS | HIGHLY DISCOUNTED**

### **FWB PRODUCT -- UNRLPRD-010623-47:**

**SOLTRONICS™ 5-IN-1 HAND BLENDER | PER 500 UNITS LOT | EXW: LOS ANGELES | FWB DISCOUNTED PRICE: **\$14.00** PER UNIT**

Please [contact us](#) for additional information:



309 Fellowship Road | East Gate Center | Suite 200 | Mt. Laurel | NJ 08054

Web-Presence: <http://freeworldbrand.com> | Liquidation Marketplace: <https://freeworldimports.com>

Commodities Webstore: <https://commodities.freeworldbrand.com/>

Phone/Fax: 609-318-0570 | Email: [bizdev@freeworldbrand.com](mailto:bizdev@freeworldbrand.com)



Global Traders: Operators of the Unconventional Inventory Liquidation Marketplace FreeWorldImports.com

---

## **FWI UNLISTED PRODUCTS | HIGHLY DISCOUNTED**

---

### **FWB PRODUCT -- UNRLPRD-010623-48:**

**BRANDED WOMEN'S LEGGING SET | PER 20,000 SETS LOT | EXW: LOS ANGELES**

**FWB DISCOUNTED PRICE: \$4.00 PER SET**

Please [contact us](#) for additional information:



---

309 Fellowship Road | East Gate Center | Suite 200 | Mt. Laurel | NJ 08054

Web-Presence: <http://freeworldbrand.com> | Liquidation Marketplace: <https://freeworldimports.com>

Commodities Webstore: <https://commodities.freeworldbrand.com/>

Phone/Fax: 609-318-0570 | Email: [bizdev@freeworldbrand.com](mailto:bizdev@freeworldbrand.com)





Global Traders: Operators of the Unconventional Inventory Liquidation Marketplace FreeWorldImports.com

## **FWI UNLISTED PRODUCTS | HIGHLY DISCOUNTED**

### **FWB PRODUCT -- UNRLPRD-010623-49:**

**BRANDED WOMEN'S & KIDS ROBES | PER 2,000 PIECES LOT | EXW: LOS ANGELES**

**FWB DISCOUNTED PRICE: \$5.50 PER PIECE**

Please [contact us](#) for additional information:



309 Fellowship Road | East Gate Center | Suite 200 | Mt. Laurel | NJ 08054

Web-Presence: <http://freeworldbrand.com> | Liquidation Marketplace: <https://freeworldimports.com>

Commodities Webstore: <https://commodities.freeworldbrand.com/>

Phone/Fax: 609-318-0570 | Email: [bizdev@freeworldbrand.com](mailto:bizdev@freeworldbrand.com)



Global Traders: Operators of the Unconventional Inventory Liquidation Marketplace FreeWorldImports.com

## **FWI UNLISTED PRODUCTS | HIGHLY DISCOUNTED**

### **FWB PRODUCT -- UNRLPRD-010623-50:**

**CARDINALHEALTH™ DISPOSABLE NITRILE EXAM GLOVES | PER 10,000 BOXES OF 200 GLOVES LOT | EXW: DALLAS | FWB DISCOUNTED PRICE: \$11.00 PER BOX OF 200 GLOVES**

Please [contact us](#) for additional information:



10,000 boxes of 200 count per box  
10,000 boxes  
1000 cases  
200 count gloves per box  
  
3000 boxes of Large  
3100 boxes of Med  
3500 boxes of Sml  
400 boxes of XL

309 Fellowship Road | East Gate Center | Suite 200 | Mt. Laurel | NJ 08054

Web-Presence: <http://freeworldbrand.com> | Liquidation Marketplace: <https://freeworldimports.com>

Commodities Webstore: <https://commodities.freeworldbrand.com/>

Phone/Fax: 609-318-0570 | Email: [bizdev@freeworldbrand.com](mailto:bizdev@freeworldbrand.com)



Global Traders: Operators of the Unconventional Inventory Liquidation Marketplace FreeWorldImports.com

## **FWI UNLISTED PRODUCTS | HIGHLY DISCOUNTED**

### **FWB PRODUCT -- UNRLPRD-010623-51:**

**MOBILE WHITEBOARD ON WHEELS 48 X 24 & 70 X36 | PER 556 UNITS LOT | EXW: NEW JERSEY | FWB DISCOUNTED PRICE: **\$35.00** UNIT**

Please [contact us](#) for additional information:



309 Fellowship Road | East Gate Center | Suite 200 | Mt. Laurel | NJ 08054

Web-Presence: <http://freeworldbrand.com> | Liquidation Marketplace: <https://freeworldimports.com>

Commodities Webstore: <https://commodities.freeworldbrand.com/>

Phone/Fax: 609-318-0570 | Email: [bizdev@freeworldbrand.com](mailto:bizdev@freeworldbrand.com)



Global Traders: Operators of the Unconventional Inventory Liquidation Marketplace FreeWorldImports.com

## **FWI UNLISTED PRODUCTS | HIGHLY DISCOUNTED**

### **FWB PRODUCT -- UNRLPRD-010623-52:**

**BUERK™ AIR FRYER TOASTER OVEN, 13.6 QUART 16-IN-1 | PER 200 UNITS LOT | EXW: LOS ANGELES | FWB DISCOUNTED PRICE: **\$60.00** UNIT**

Please [contact us](#) for additional information:

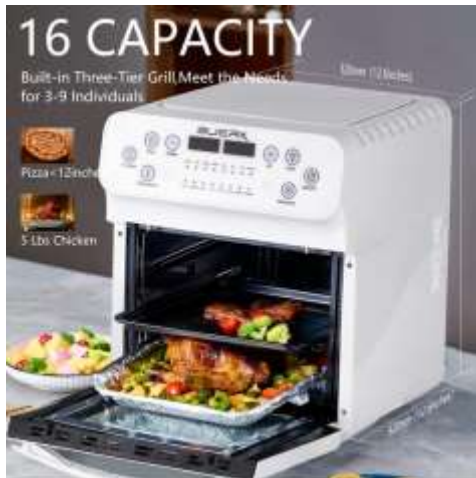

309 Fellowship Road | East Gate Center | Suite 200 | Mt. Laurel | NJ 08054

Web-Presence: <http://freeworldbrand.com> | Liquidation Marketplace: <https://freeworldimports.com>

Commodities Webstore: <https://commodities.freeworldbrand.com/>

Phone/Fax: 609-318-0570 | Email: [bizdev@freeworldbrand.com](mailto:bizdev@freeworldbrand.com)



Global Traders: Operators of the Unconventional Inventory Liquidation Marketplace FreeWorldImports.com

## FWI UNLISTED PRODUCTS | HIGHLY DISCOUNTED

### FWB PRODUCT -- UNRLPRD-010623-53:

WHITEDUCK™ WOMEN AND MEN V-NECK PROFESSIONAL MEDICAL UNIFORM SCRUBS SET | PER 14,616 SETS LOT | EXW: KNOXVILLE, TN | FWB DISCOUNTED PRICE: **\$4.50** PER SET

Please [contact us](#) for additional information:



#### SIZE CHART (measurements in inches)

Style	TUNIC		TROUSER		
	Bust	Relaxed Waist	Stretched Waist	Hips	In seam
XXS	34-36	26-28	36-38	33-35	29
XS	36-38	26-28	36-38	37-39	29.5
S	39-41	29-31	39-41	41-43	30
M	42-44	32-34	42-44	44-46	30.5
L	45-47	35-37	45-47	47-49	31
XL	48-50	38-40	48-50	50-52	31.5
2XL	51-54	41-43	51-53	54-56	32
3XL	55-58	44-46	54-56	58-60	32.5
4XL	59-61	47-49	57-59	62-64	32.5
5XL	59-61	51-53	61-63	66-68	33

#### HOW TO MEASURE

Bust: Measure under the arms around the fullest part of your bust/chest.  
 Waist: Measure around the smallest part of your waist, under the natural waistline.  
 Hip: Measure around the fullest part of your hip (standing with feet together).  
 Inseam: Measure along the inside of the leg, from just below the crotch to 1" below the ankle.

#### DISCLAIMER:

These are Unisex Classic Fit scrubs. Please use the size chart to help determine your size. Order one size down for a more modern/light fit.

Product Sizes	UPC	Total Units
Scrubs (Pair) Small, Green	810055834846	1671
Scrubs (Pair) Medium, Green	810055834853	1517
Scrubs (Pair) Large, Green	810055834860	1482
Scrubs (Pair) X-Large, Green	810055834877	1569
Scrubs (Pair) 2X-Large, Green	810055834884	685
Scrubs (Pair) 3X-Large, Green	810055834891	395
Scrubs (Pair) 4X-Large, Green	810055834907	414
Scrubs (Pair) Small, Blue	810055834631	1527
Scrubs (Pair) Medium, Blue	810055834648	1476
Scrubs (Pair) Large, Blue	810055834655	1326
Scrubs (Pair) X-Large, Blue	810055834662	1517
Scrubs (Pair) XX-Large, Blue	810055834679	420
Scrubs (Pair) 3X-Large, Blue	810055834686	246
Scrubs (Pair) 4X-Large, Blue	810055834693	371
		<b>14616</b>

309 Fellowship Road | East Gate Center | Suite 200 | Mt. Laurel | NJ 08054

Web-Presence: <http://freeworldbrand.com> | Liquidation Marketplace: <https://freeworldimports.com>

Commodities Webstore: <https://commodities.freeworldbrand.com/>

Phone/Fax: 609-318-0570 | Email: [bizdev@freeworldbrand.com](mailto:bizdev@freeworldbrand.com)



Global Traders: Operators of the Unconventional Inventory Liquidation Marketplace FreeWorldImports.com

## **FWI UNLISTED PRODUCTS | HIGHLY DISCOUNTED**

### **FWB PRODUCT -- UNRLPRD-010623-54:**

**BRANDED NECK GAITERS - (3-PACK) | PER 242,265 PER PACK OF THREE (3) LOTS | EXW: LAS VEGAS | FWB DISCOUNTED PRICE: **\$2.00** PER PACT OF THREE (3) NECK GAITERS**

Please [contact us](#) for additional information:

## **240,000 3-PACKS OF NECK GAITERS**



ALL BRAND NEW, FACTORY FRESH, CASE-PACKAGED, WITH UPC CODES

**COMPLETE DETAILED INVENTORY AVAILABLE - FOB LAS VEGAS, NV**

309 Fellowship Road | East Gate Center | Suite 200 | Mt. Laurel | NJ 08054

Web-Presence: <http://freeworldbrand.com> | Liquidation Marketplace: <https://freeworldimports.com>

Commodities Webstore: <https://commodities.freeworldbrand.com/>

Phone/Fax: 609-318-0570 | Email: [bizdev@freeworldbrand.com](mailto:bizdev@freeworldbrand.com)



Global Traders: Operators of the Unconventional Inventory Liquidation Marketplace FreeWorldImports.com

---

## **FWI UNLISTED PRODUCTS | HIGHLY DISCOUNTED**

---

### **FWB PRODUCT -- UNRLPRD-010623-55:**

**ZOREYA™ MAKEUP 15-PIECES BRUSH SET | PER 1,000 SETS LOT | EXW: LOS ANGELES**

**FWB DISCOUNTED PRICE: \$5.00 PER SET**

Please [contact us](#) for additional information:



---

309 Fellowship Road | East Gate Center | Suite 200 | Mt. Laurel | NJ 08054

Web-Presence: <http://freeworldbrand.com> | Liquidation Marketplace: <https://freeworldimports.com>

Commodities Webstore: <https://commodities.freeworldbrand.com/>

Phone/Fax: 609-318-0570 | Email: [bizdev@freeworldbrand.com](mailto:bizdev@freeworldbrand.com)



Global Traders: Operators of the Unconventional Inventory Liquidation Marketplace FreeWorldImports.com

## **FWI UNLISTED PRODUCTS | HIGHLY DISCOUNTED**

### **FWB PRODUCT -- UNRLPRD-010623-56:**

**JUNO & CO.™ CLEANSING MAKEUP REMOVER (85 Grams/3 Ounces) | PER 9,000 BOX LOTS | EXW: LOS ANGELES | FWB DISCOUNTED PRICE: **\$2.00** PER BOX**

Please [contact us](#) for additional information:



309 Fellowship Road | East Gate Center | Suite 200 | Mt. Laurel | NJ 08054

Web-Presence: <http://freeworldbrand.com> | Liquidation Marketplace: <https://freeworldimports.com>

Commodities Webstore: <https://commodities.freeworldbrand.com/>

Phone/Fax: 609-318-0570 | Email: [bizdev@freeworldbrand.com](mailto:bizdev@freeworldbrand.com)





Global Traders: Operators of the Unconventional Inventory Liquidation Marketplace FreeWorldImports.com

## **FWI UNLISTED PRODUCTS | HIGHLY DISCOUNTED**

### **FWB PRODUCT -- UNRLPRD-010623-56:**

**MANZOO™ KING & QUEEN SIZE MATTRESS PAD | PER 1,500 UNITS LOT | EXW LOS ANGELES**

**FWB DISCOUNTED PRICE: \$9.00 PER UNIT**

Please [contact us](#) for additional information:



309 Fellowship Road | East Gate Center | Suite 200 | Mt. Laurel | NJ 08054

Web-Presence: <http://freeworldbrand.com> | Liquidation Marketplace: <https://freeworldimports.com>

Commodities Webstore: <https://commodities.freeworldbrand.com/>

Phone/Fax: 609-318-0570 | Email: [bizdev@freeworldbrand.com](mailto:bizdev@freeworldbrand.com)



Global Traders: Operators of the Unconventional Inventory Liquidation Marketplace FreeWorldImports.com

## **FWI UNLISTED PRODUCTS | HIGHLY DISCOUNTED**

### **FWB PRODUCT -- UNRLPRD-010623-57:**

**PAUL MITCHELL™ & SUMMER FRIDAY SHAMPOO AND CONDITIONER | PER 4,196 UNITS LOT  
| EXW: LOS ANGELES | FWB DISCOUNTED PRICE: **\$8.00** PER UNIT**

Please [contact us](#) for additional information:



ITEMS	TOTAL
PAUL MITCHELL SUGAR HAIR SPARAY 8.5 OZ	966
PAUL MITCHELL SUGAR DRY CONDITIONER 4.7 OZ	867
PAUL MITCHELL AWAPUHI DRY SHAMPOO FOAM 2 OZ	754
SUMMER FRIDAYS OVERTIME MASK 2.25 OZ	1573
	<b>4196</b>

309 Fellowship Road | East Gate Center | Suite 200 | Mt. Laurel | NJ 08054

Web-Presence: <http://freeworldbrand.com> | Liquidation Marketplace: <https://freeworldimports.com>

Commodities Webstore: <https://commodities.freeworldbrand.com/>

Phone/Fax: 609-318-0570 | Email: [bizdev@freeworldbrand.com](mailto:bizdev@freeworldbrand.com)



Global Traders: Operators of the Unconventional Inventory Liquidation Marketplace FreeWorldImports.com

## **FWI UNLISTED PRODUCTS | HIGHLY DISCOUNTED**

### **FWB PRODUCT -- UNRLPRD-010623-57:**

**BRANDED WOMEN'S CARDIGAN | PER 11,000 PIECES LOT | EXW: LOS ANGELES**

**FWB DISCOUNTED PRICE: **\$4.00** PER PIECE**

Please [contact us](#) for additional information:



**BREAKDOWN:**

- **Black:** 1,000 Pieces
- **White:** 10,000 Pieces

**SIZES:** S-M-L-XL(1-2-2-1)

309 Fellowship Road | East Gate Center | Suite 200 | Mt. Laurel | NJ 08054

**Web-Presence:** <http://freeworldbrand.com> | **Liquidation Marketplace:** <https://freeworldimports.com>

Commodities Webstore: <https://commodities.freeworldbrand.com/>

**Phone/Fax:** 609-318-0570 | **Email:** bizdev@freeworldbrand.com



Global Traders: Operators of the Unconventional Inventory Liquidation Marketplace FreeWorldImports.com

---

## **FWI UNLISTED PRODUCTS | HIGHLY DISCOUNTED**

---

### **FWB PRODUCT -- UNRLPRD-010623-58:**

**VTECH™ DRILL AND LEARN TOOLBOX | PER 2,000 UNITS LOT | EXW: LOS ANGELES**

**FWB DISCOUNTED PRICE: \$9.00 PER UNIT**

Please [contact us](#) for additional information:



---

309 Fellowship Road | East Gate Center | Suite 200 | Mt. Laurel | NJ 08054

Web-Presence: <http://freeworldbrand.com> | Liquidation Marketplace: <https://freeworldimports.com>

Commodities Webstore: <https://commodities.freeworldbrand.com/>

Phone/Fax: 609-318-0570 | Email: [bizdev@freeworldbrand.com](mailto:bizdev@freeworldbrand.com)



Global Traders: Operators of the Unconventional Inventory Liquidation Marketplace FreeWorldImports.com

---

## **FWI UNLISTED PRODUCTS | HIGHLY DISCOUNTED**

---

### **FWB PRODUCT -- UNRLPRD-010623-59:**

**WATERFORD™ QUEEN SIZE MATTRESS COMFORTER | PER 900 UNITS LOT | EXW: LOS ANGELES | FWB DISCOUNTED PRICE: **\$18.50** PER UNIT**

Please [contact us](#) for additional information:



---

309 Fellowship Road | East Gate Center | Suite 200 | Mt. Laurel | NJ 08054

Web-Presence: <http://freeworldbrand.com> | Liquidation Marketplace: <https://freeworldimports.com>

Commodities Webstore: <https://commodities.freeworldbrand.com/>

Phone/Fax: 609-318-0570 | Email: [bizdev@freeworldbrand.com](mailto:bizdev@freeworldbrand.com)



Global Traders: Operators of the Unconventional Inventory Liquidation Marketplace FreeWorldImports.com

---

## **FWI UNLISTED PRODUCTS | HIGHLY DISCOUNTED**

---

### **FWB PRODUCT -- UNRLPRD-010623-60:**

**KANGAROO™ DOORBELL CAMERA WITH CHIME | PER 73,000 UNITS LOT | EXW: ATLANTA**

**FWB DISCOUNTED PRICE: \$9.50 PER UNIT**

Please [contact us](#) for additional information:

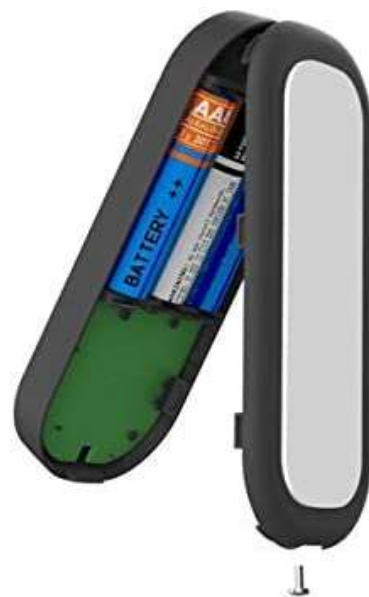

---

309 Fellowship Road | East Gate Center | Suite 200 | Mt. Laurel | NJ 08054

Web-Presence: <http://freeworldbrand.com> | Liquidation Marketplace: <https://freeworldimports.com>

Commodities Webstore: <https://commodities.freeworldbrand.com/>

Phone/Fax: 609-318-0570 | Email: [bizdev@freeworldbrand.com](mailto:bizdev@freeworldbrand.com)



Global Traders: Operators of the Unconventional Inventory Liquidation Marketplace [FreeWorldImports.com](http://FreeWorldImports.com)

---

## **FWI UNLISTED PRODUCTS | HIGHLY DISCOUNTED**

---

### **FWB PRODUCT -- UNRLPRD-010623-61:**

**HAPPY LIVING™ HOME OFFICE WORK CHAIR | PER 600 UNITS LOT | EXW: LOS ANGELES**

**FWB DISCOUNTED PRICE: \$21.50 PER UNIT**

Please [contact us](#) for additional information:



---

309 Fellowship Road | East Gate Center | Suite 200 | Mt. Laurel | NJ 08054

Web-Presence: <http://freeworldbrand.com> | Liquidation Marketplace: <https://freeworldimports.com>

Commodities Webstore: <https://commodities.freeworldbrand.com/>

Phone/Fax: 609-318-0570 | Email: [bizdev@freeworldbrand.com](mailto:bizdev@freeworldbrand.com)



Global Traders: Operators of the Unconventional Inventory Liquidation Marketplace FreeWorldImports.com

---

## **FWI UNLISTED PRODUCTS | HIGHLY DISCOUNTED**

---

### **FWB PRODUCT -- UNRLPRD-010623-62:**

**GAMING CHAIR CLOSEOUT | PER 1,750 UNITS LOT | EXW: LOS ANGELES | FWB DISCOUNTED PRICE: **\$33.50** PER UNIT**

Please [contact us](#) for additional information:



---

309 Fellowship Road | East Gate Center | Suite 200 | Mt. Laurel | NJ 08054

Web-Presence: <http://freeworldbrand.com> | Liquidation Marketplace: <https://freeworldimports.com>

Commodities Webstore: <https://commodities.freeworldbrand.com/>

Phone/Fax: 609-318-0570 | Email: [bizdev@freeworldbrand.com](mailto:bizdev@freeworldbrand.com)





Global Traders: Operators of the Unconventional Inventory Liquidation Marketplace FreeWorldImports.com

## **FWI UNLISTED PRODUCTS | HIGHLY DISCOUNTED**

### **FWB PRODUCT -- UNRLPRD-010623-63:**

**HAPPY LIVING™ STANDING DESK CONVERTER 34 INCHES COMPUTER DESK | PER 700 UNITS LOT | EXW: LOS ANGELES | FWB DISCOUNTED PRICE: **\$19.50** PER UNIT**

Please [contact us](#) for additional information:



309 Fellowship Road | East Gate Center | Suite 200 | Mt. Laurel | NJ 08054

Web-Presence: <http://freeworldbrand.com> | Liquidation Marketplace: <https://freeworldimports.com>

Commodities Webstore: <https://commodities.freeworldbrand.com/>

Phone/Fax: 609-318-0570 | Email: [bizdev@freeworldbrand.com](mailto:bizdev@freeworldbrand.com)



Global Traders: Operators of the Unconventional Inventory Liquidation Marketplace FreeWorldImports.com

## **FWI UNLISTED PRODUCTS | HIGHLY DISCOUNTED**

### **FWB PRODUCT -- UNRLPRD-010623-64:**

**FOREVER 21™ LADIES SNEAKERS | PER 5,000 PAIRS LOT | EXW: LOS ANGELES | FWB DISCOUNTED PRICE: **\$4.50** PER PAIR**

Please [contact us](#) for additional information:



309 Fellowship Road | East Gate Center | Suite 200 | Mt. Laurel | NJ 08054

Web-Presence: <http://freeworldbrand.com> | Liquidation Marketplace: <https://freeworldimports.com>

Commodities Webstore: <https://commodities.freeworldbrand.com/>

Phone/Fax: 609-318-0570 | Email: [bizdev@freeworldbrand.com](mailto:bizdev@freeworldbrand.com)



Global Traders: Operators of the Unconventional Inventory Liquidation Marketplace FreeWorldImports.com

---

## **FWI UNLISTED PRODUCTS | HIGHLY DISCOUNTED**

---

### **FWB PRODUCT -- UNRLPRD-010623-65:**

**VERA BRADLEY™ WOMEN'S SUNGLASSES | PER 900 UNITS LOT | EXW: MIAMI**

**FWB DISCOUNTED PRICE: \$9.50 PER UNIT**

*Please [contact us](#) for additional information:*



---

309 Fellowship Road | East Gate Center | Suite 200 | Mt. Laurel | NJ 08054

**Web-Presence:** <http://freeworldbrand.com> | **Liquidation Marketplace:** <https://freeworldimports.com>

Commodities Webstore: <https://commodities.freeworldbrand.com/>

**Phone/Fax:** 609-318-0570 | **Email:** [bizdev@freeworldbrand.com](mailto:bizdev@freeworldbrand.com)



Global Traders: Operators of the Unconventional Inventory Liquidation Marketplace FreeWorldImports.com

---

## **FWI UNLISTED PRODUCTS | HIGHLY DISCOUNTED**

---

### **FWB PRODUCT -- UNRLPRD-010623-66:**

SWISS SAFE™ 120-PIECE PROFESSIONAL FIRST AID KIT | PER 15,000 UNITS LOT | EXW:  
CHICAGO | FWB DISCOUNTED PRICE: **\$9.50** PER UNIT

Please [contact us](#) for additional information:



---

309 Fellowship Road | East Gate Center | Suite 200 | Mt. Laurel | NJ 08054

Web-Presence: <http://freeworldbrand.com> | Liquidation Marketplace: <https://freeworldimports.com>

Commodities Webstore: <https://commodities.freeworldbrand.com/>

Phone/Fax: 609-318-0570 | Email: [bizdev@freeworldbrand.com](mailto:bizdev@freeworldbrand.com)



Global Traders: Operators of the Unconventional Inventory Liquidation Marketplace FreeWorldImports.com

## **FWI UNLISTED PRODUCTS | HIGHLY DISCOUNTED**

### **FWB PRODUCT -- UNRLPRD-010623-67:**

**NAUTICA™ 4 PIECE BEARD GROOMING ESSENTIALS KIT WITH RAZOR | PER 8,129 UNITS LOT  
| EXW: LOS ANGELES | FWB DISCOUNTED PRICE: **\$5.00** PER UNIT**

Please [contact us](#) for additional information:



### **FWB PRODUCT -- UNRLPRD-010623-68:**

**PLUTO™ POWER BANK WITH CARABINER CHARGES ANY CELLPHONES | PER 2,000 UNITS LOT  
| EXW: LOS ANGELES | FWB DISCOUNTED PRICE: **\$5.50** PER UNIT**

Please [contact us](#) for additional information:



- 2600 mAh
- Comes with Carabiner Clip On For Clipping onto Purse, Backpack, Other
- Comes with USB cord for Charging

309 Fellowship Road | East Gate Center | Suite 200 | Mt. Laurel | NJ 08054

Web-Presence: <http://freeworldbrand.com> | Liquidation Marketplace: <https://freeworldimports.com>

Commodities Webstore: <https://commodities.freeworldbrand.com/>

Phone/Fax: 609-318-0570 | Email: [bizdev@freeworldbrand.com](mailto:bizdev@freeworldbrand.com)



Global Traders: Operators of the Unconventional Inventory Liquidation Marketplace FreeWorldImports.com

## **FWI UNLISTED PRODUCTS | HIGHLY DISCOUNTED**

### **FWB PRODUCT -- UNRLPRD-010623-69:**

**PROSPORT™ 16" KIDS BACKPACK IN ASSORTED COLORS | PER 16,270 PIECES LOT | EXW: LOS ANGELES | FWB DISCOUNTED PRICE: **\$5.50** PER PIECE**

Please [contact us](#) for additional information:



309 Fellowship Road | East Gate Center | Suite 200 | Mt. Laurel | NJ 08054

Web-Presence: <http://freeworldbrand.com> | Liquidation Marketplace: <https://freeworldimports.com>

Commodities Webstore: <https://commodities.freeworldbrand.com/>

Phone/Fax: 609-318-0570 | Email: [bizdev@freeworldbrand.com](mailto:bizdev@freeworldbrand.com)



Global Traders: Operators of the Unconventional Inventory Liquidation Marketplace FreeWorldImports.com

## **FWI UNLISTED PRODUCTS | HIGHLY DISCOUNTED**

### **FWB PRODUCT -- UNRLPRD-010623-70:**

**PAULIDA™ TRAVEL MATE CONVENIENT INFRARED BBQ GRILL FOR CAMPING & PICNIC | PER 500 UNIT LOT | EXW: CHICAGO | FWB DISCOUNTED PRICE: **\$85.00** PER UNIT**

Please [contact us](#) for additional information:



309 Fellowship Road | East Gate Center | Suite 200 | Mt. Laurel | NJ 08054

Web-Presence: <http://freeworldbrand.com> | Liquidation Marketplace: <https://freeworldimports.com>

Commodities Webstore: <https://commodities.freeworldbrand.com/>

Phone/Fax: 609-318-0570 | Email: [bizdev@freeworldbrand.com](mailto:bizdev@freeworldbrand.com)



Global Traders: Operators of the Unconventional Inventory Liquidation Marketplace FreeWorldImports.com

## **FWI UNLISTED PRODUCTS | HIGHLY DISCOUNTED**

### **FWB PRODUCT -- UNRLPRD-010623-71:**

**PLUGGED in TOURMALINE™ MINI DEEP WAYER | PER 1,600 UNITS LOT | EXW: LOS ANGELES**

**FWB DISCOUNTED PRICE: \$9.00 PER UNIT**

Please [contact us](#) for additional information:



309 Fellowship Road | East Gate Center | Suite 200 | Mt. Laurel | NJ 08054

Web-Presence: <http://freeworldbrand.com> | Liquidation Marketplace: <https://freeworldimports.com>

Commodities Webstore: <https://commodities.freeworldbrand.com/>

Phone/Fax: 609-318-0570 | Email: [bizdev@freeworldbrand.com](mailto:bizdev@freeworldbrand.com)





Global Traders: Operators of the Unconventional Inventory Liquidation Marketplace FreeWorldImports.com

## **FWI UNLISTED PRODUCTS | HIGHLY DISCOUNTED**

### **FWB PRODUCT -- UNRLPRD-010623-72:**

**ANNIE CHUN'S™ COOKED WHITE STICKY RICE-INSTANT, MICROWAVEABLE, 7.4 OUNCES | PER 3,360- SIX (6)-PACK CASES LOT | EXW: LOS ANGELES | FWB DISCOUNTED PRICE: \$7.00 PER 6-PACK CASE**

Please [contact us](#) for additional information:



309 Fellowship Road | East Gate Center | Suite 200 | Mt. Laurel | NJ 08054

Web-Presence: <http://freeworldbrand.com> | Liquidation Marketplace: <https://freeworldimports.com>

Commodities Webstore: <https://commodities.freeworldbrand.com/>

Phone/Fax: 609-318-0570 | Email: [bizdev@freeworldbrand.com](mailto:bizdev@freeworldbrand.com)



Global Traders: Operators of the Unconventional Inventory Liquidation Marketplace FreeWorldImports.com

## **FWI UNLISTED PRODUCTS | HIGHLY DISCOUNTED**

### **FWB PRODUCT -- UNRLPRD-010623-73**

**MICA™ MINI COSMETIC FRIDGE | PER 10,000 UNITS LOT | EXW: LOS ANGELES**

**FWB DISCOUNTED PRICE: \$12.50 PER UNIT**

Please [contact us](#) for additional information:



**SIZE:** 7.4 X 9.7 X 10.7 INCHES

309 Fellowship Road | East Gate Center | Suite 200 | Mt. Laurel | NJ 08054

Web-Presence: <http://freeworldbrand.com> | Liquidation Marketplace: <https://freeworldimports.com>

Commodities Webstore: <https://commodities.freeworldbrand.com/>

Phone/Fax: 609-318-0570 | Email: [bizdev@freeworldbrand.com](mailto:bizdev@freeworldbrand.com)



Global Traders: Operators of the Unconventional Inventory Liquidation Marketplace FreeWorldImports.com

## **FWI UNLISTED PRODUCTS | HIGHLY DISCOUNTED**

### **FWB PRODUCT -- UNRLPRD-010623-74**

**WATER BOTTLES CLOSEOUT | PER 18,000 UNITS LOT | EXW: LOS ANGELES**

**FWB DISCOUNTED PRICE: \$3.00 PER UNIT**

Please [contact us](#) for additional information:



309 Fellowship Road | East Gate Center | Suite 200 | Mt. Laurel | NJ 08054

Web-Presence: <http://freeworldbrand.com> | Liquidation Marketplace: <https://freeworldimports.com>

Commodities Webstore: <https://commodities.freeworldbrand.com/>

Phone/Fax: 609-318-0570 | Email: [bizdev@freeworldbrand.com](mailto:bizdev@freeworldbrand.com)



Global Traders: Operators of the Unconventional Inventory Liquidation Marketplace FreeWorldImports.com

---

## **FWI UNLISTED PRODUCTS | HIGHLY DISCOUNTED**

---

### **FWB PRODUCT -- UNRLPRD-010623-75:**

**BRANDED MEN & WOMEN ASSORTED BRANDED BOOTS | PER 700 PAIRS LOT | EXW: LOS ANGELES | FWB DISCOUNTED PRICE: \$20.00 PER PAIR**

Please [contact us](#) for additional information:



---

309 Fellowship Road | East Gate Center | Suite 200 | Mt. Laurel | NJ 08054

Web-Presence: <http://freeworldbrand.com> | Liquidation Marketplace: <https://freeworldimports.com>

Commodities Webstore: <https://commodities.freeworldbrand.com/>

Phone/Fax: 609-318-0570 | Email: [bizdev@freeworldbrand.com](mailto:bizdev@freeworldbrand.com)



Global Traders: Operators of the Unconventional Inventory Liquidation Marketplace FreeWorldImports.com

## **FWI UNLISTED PRODUCTS | HIGHLY DISCOUNTED**



309 Fellowship Road | East Gate Center | Suite 200 | Mt. Laurel | NJ 08054

Web-Presence: <http://freeworldbrand.com> | Liquidation Marketplace: <https://freeworldimports.com>

Commodities Webstore: <https://commodities.freeworldbrand.com/>

Phone/Fax: 609-318-0570 | Email: [bizdev@freeworldbrand.com](mailto:bizdev@freeworldbrand.com)



Global Traders: Operators of the Unconventional Inventory Liquidation Marketplace FreeWorldImports.com

## **FWI UNLISTED PRODUCTS | HIGHLY DISCOUNTED**



### **NOTE:**

- Mostly sizes 8-11
- Mainly adult men's.
- Few sneakers.
- No detail manifest is available

309 Fellowship Road | East Gate Center | Suite 200 | Mt. Laurel | NJ 08054

Web-Presence: <http://freeworldbrand.com> | Liquidation Marketplace: <https://freeworldimports.com>

Commodities Webstore: <https://commodities.freeworldbrand.com/>

Phone/Fax: 609-318-0570 | Email: [bizdev@freeworldbrand.com](mailto:bizdev@freeworldbrand.com)



Global Traders: Operators of the Unconventional Inventory Liquidation Marketplace FreeWorldImports.com

---

## **FWI UNLISTED PRODUCTS | HIGHLY DISCOUNTED**

---

### **FWB PRODUCT -- UNRLPRD-010623-76**

**NEXT LEVEL™ UNISEX HEAVYWEIGHT COTTON LONG SLEEVE T-SHIRTS | PER 120,199 PIECES LOT | EXW: LOS ANGELES | FWB DISCOUNTED PRICE: \$2.00 PER PIECE**

Please [contact us](#) for additional information:



**Fabric Platform** : 100% Heavyweight Cotton Jersey  
**Fabric** : 100% Cotton (H.Grey - 90% Cotton, 10% Polyester)  
**Fabric Weight** : 190g, 5.6oz  
**Thread Weight** : 20 Singles  
**Binding** : Self 3/8" Shoulder To Shoulder Binding  
**Collar** : Crew Neck  
**Fit Type** : Classic  
**Size Range** : XS-4XL

---

309 Fellowship Road | East Gate Center | Suite 200 | Mt. Laurel | NJ 08054

Web-Presence: <http://freeworldbrand.com> | Liquidation Marketplace: <https://freeworldimports.com>

Commodities Webstore: <https://commodities.freeworldbrand.com/>

Phone/Fax: 609-318-0570 | Email: [bizdev@freeworldbrand.com](mailto:bizdev@freeworldbrand.com)



Global Traders: Operators of the Unconventional Inventory Liquidation Marketplace FreeWorldImports.com

---

## **FWI UNLISTED PRODUCTS | HIGHLY DISCOUNTED**

---

### **FWB PRODUCT -- UNRLPRD-010623-77**

**NEXT LEVEL™ 9601 UNISEX LAGUNA FULL ZIP HOODIE | PER 29,893 PIECES LOT | EXW: LOS ANGELES | FWB DISCOUNTED PRICE: **\$4.00** PER PIECE**

Please [contact us](#) for additional information:



---

309 Fellowship Road | East Gate Center | Suite 200 | Mt. Laurel | NJ 08054

Web-Presence: <http://freeworldbrand.com> | Liquidation Marketplace: <https://freeworldimports.com>

Commodities Webstore: <https://commodities.freeworldbrand.com/>

Phone/Fax: 609-318-0570 | Email: [bizdev@freeworldbrand.com](mailto:bizdev@freeworldbrand.com)





Global Traders: Operators of the Unconventional Inventory Liquidation Marketplace FreeWorldImports.com

---

## **FWI UNLISTED PRODUCTS | HIGHLY DISCOUNTED**

---



---

309 Fellowship Road | East Gate Center | Suite 200 | Mt. Laurel | NJ 08054

Web-Presence: <http://freeworldbrand.com> | Liquidation Marketplace: <https://freeworldimports.com>

Commodities Webstore: <https://commodities.freeworldbrand.com/>

Phone/Fax: 609-318-0570 | Email: [bizdev@freeworldbrand.com](mailto:bizdev@freeworldbrand.com)



Global Traders: Operators of the Unconventional Inventory Liquidation Marketplace FreeWorldImports.com

## **FWI UNLISTED PRODUCTS | HIGHLY DISCOUNTED**

Fabric Platform	French Terry Fleece
Fabric	60% Combed Ring-Spun Cotton, 40% Polyester French Terry Fleece
Fabric Weight	180g, 5.3oz
Thread Weight	30 Singles
Binding	Contrast 3/8" Binding Around Neckline
Collar	Hoodie
Fit Type	Classic
Size Range	XS-3XL

309 Fellowship Road | East Gate Center | Suite 200 | Mt. Laurel | NJ 08054

Web-Presence: <http://freeworldbrand.com> | Liquidation Marketplace: <https://freeworldimports.com>

Commodities Webstore: <https://commodities.freeworldbrand.com/>

Phone/Fax: 609-318-0570 | Email: [bizdev@freeworldbrand.com](mailto:bizdev@freeworldbrand.com)



Global Traders: Operators of the Unconventional Inventory Liquidation Marketplace FreeWorldImports.com

# FWI UNLISTED PRODUCTS | HIGHLY DISCOUNTED

## FWB PRODUCT -- UNRLPRD-010623-78

COMPACT UMBRELLA | PER 20,000 UNITS LOT | EXW: LOS ANGELES

FWB DISCOUNTED PRICE: **\$4.00** PER UNIT

Please [contact us](#) for additional information:

**AUTOMATIC OPEN/CLOSE** **WEATHER ZONE**

STYLE: 880-D

PUSH-BUTTON  
AUTOMATIC  
OPEN/CLOSE

SURE-GRIP RUBBERIZED  
COLOR MATCHING  
HANDLE

ROUND EURO TIPS

PRODUCT FEATURES	ASSORTMENT
Large Arc Coverage	<p>ROYAL 0-82815-46861-7</p> <p>BLACK 0-82815-46864-8</p> <p>RED 0-82815-46865-5</p> <p>LEOPARD 0-82815-46862-4</p>
Windproof Automatic Open/Close Frame	
Sure-Grip Rubberized Color Matching Handle	
Color: Assorted Solids and Prints	
Inner Pack: 2 Umbrellas	
Case Pack: 24 Umbrellas	
UPC: Assorted By Color	

CHERRY INTERNATIONAL

309 Fellowship Road | East Gate Center | Suite 200 | Mt. Laurel | NJ 08054

Web-Presence: <http://freeworldbrand.com> | Liquidation Marketplace: <https://freeworldimports.com>

Commodities Webstore: <https://commodities.freeworldbrand.com/>

Phone/Fax: 609-318-0570 | Email: [bizdev@freeworldbrand.com](mailto:bizdev@freeworldbrand.com)



Global Traders: Operators of the Unconventional Inventory Liquidation Marketplace FreeWorldImports.com

---

## **FWI UNLISTED PRODUCTS | HIGHLY DISCOUNTED**

---

### **FWB PRODUCT -- UNRLPRD-010623-79**

70 X 40 INCHES BEACH TOWEL | PER 1,200 PIECES LOT | EXW: LOS ANGELES

FWB DISCOUNTED PRICE: **\$4.00** PER PIECE

Please [contact us](#) for additional information:



---

309 Fellowship Road | East Gate Center | Suite 200 | Mt. Laurel | NJ 08054

Web-Presence: <http://freeworldbrand.com> | Liquidation Marketplace: <https://freeworldimports.com>

Commodities Webstore: <https://commodities.freeworldbrand.com/>

Phone/Fax: 609-318-0570 | Email: [bizdev@freeworldbrand.com](mailto:bizdev@freeworldbrand.com)



Global Traders: Operators of the Unconventional Inventory Liquidation Marketplace FreeWorldImports.com

---

## **FWI UNLISTED PRODUCTS | HIGHLY DISCOUNTED**

---

### **FWB PRODUCT -- UNRLPRD-010623-80**

**KIDS ASSORTED WINTER PADDING JACKET | PER 400 PIECES LOT | EXW: LOS ANGELES**  
**FWB DISCOUNTED PRICE: \$6.00 PER PIECE**

Please [contact us](#) for additional information:



---

309 Fellowship Road | East Gate Center | Suite 200 | Mt. Laurel | NJ 08054

Web-Presence: <http://freeworldbrand.com> | Liquidation Marketplace: <https://freeworldimports.com>

Commodities Webstore: <https://commodities.freeworldbrand.com/>

Phone/Fax: 609-318-0570 | Email: [bizdev@freeworldbrand.com](mailto:bizdev@freeworldbrand.com)



Global Traders: Operators of the Unconventional Inventory Liquidation Marketplace FreeWorldImports.com

## **FWI UNLISTED PRODUCTS | HIGHLY DISCOUNTED**

### **FWB PRODUCT -- UNRLPRD-010623-81**

JEN&PO™ 3PCS (20, 24 AND 28 INCHES) LUGGAGE SET | PER 100 SETS LOT | EXW: NEW YORK  
FWB DISCOUNTED PRICE: **\$90.00** PER SET

Please [contact us](#) for additional information:



COLOR	QUANTITY
Black	30 Sets
Red	20 sets
Grey	20 Sets
Navy	30 Sets

309 Fellowship Road | East Gate Center | Suite 200 | Mt. Laurel | NJ 08054

Web-Presence: <http://freeworldbrand.com> | Liquidation Marketplace: <https://freeworldimports.com>

Commodities Webstore: <https://commodities.freeworldbrand.com/>

Phone/Fax: 609-318-0570 | Email: [bizdev@freeworldbrand.com](mailto:bizdev@freeworldbrand.com)



Global Traders: Operators of the Unconventional Inventory Liquidation Marketplace FreeWorldImports.com

---

## **FWI UNLISTED PRODUCTS | HIGHLY DISCOUNTED**

---

**NEWLY LISTED PRODUCTS ARE ALSO [AVAILABLE HERE](#)** | Please commit to your records and orchestrate accordingly.

**NOTE:** Detailed information for available listed item(s) are available at: [FreeworldImports.com](http://FreeworldImports.com) – “[The Unconventional Inventory Liquidation Marketplace](#)”

---

309 Fellowship Road | East Gate Center | Suite 200 | Mt. Laurel | NJ 08054

Web-Presence: <http://freeworldbrand.com> | Liquidation Marketplace: <https://freeworldimports.com>

Commodities Webstore: <https://commodities.freeworldbrand.com/>

Phone/Fax: 609-318-0570 | Email: [bizdev@freeworldbrand.com](mailto:bizdev@freeworldbrand.com)



Global Traders: Operators of the Unconventional Inventory Liquidation Marketplace FreeWorldImports.com

---

**FWI UNLISTED PRODUCTS | HIGHLY DISCOUNTED**

---

---

**OTHER FREEWORLD INVENTORY LIQUIDATION SERVICES OFFERINGS | NON-AUCTION ITEMS**

---

*Please click on the image or the associated hyperlink to learn more*

---



**[FWB – NON-AUCTION COMMODITIES WEBSTORE](#)**

---

309 Fellowship Road | East Gate Center | Suite 200 | Mt. Laurel | NJ 08054

Web-Presence: <http://freeworldbrand.com> | Liquidation Marketplace: <https://freeworldimports.com>

Commodities Webstore: <https://commodities.freeworldbrand.com/>

Phone/Fax: 609-318-0570 | Email: [bizdev@freeworldbrand.com](mailto:bizdev@freeworldbrand.com)





Global Traders: Operators of the Unconventional Inventory Liquidation Marketplace FreeWorldImports.com

---

## **FWI UNLISTED PRODUCTS | HIGHLY DISCOUNTED**

---

*Please click on the image or the associated hyperlink to learn more*

---

# **SOURCE HERE**

freeworldimports.com

**FREE  
WORLD  
IMPORTS**  
A Translucent Marketing Company

**SOURCE YOUR PRODUCTS HERE | DELIVERED DUTY PAID (DDP)**

---

309 Fellowship Road | East Gate Center | Suite 200 | Mt. Laurel | NJ 08054

Web-Presence: <http://freeworldbrand.com> | Liquidation Marketplace: <https://freeworldimports.com>

Commodities Webstore: <https://commodities.freeworldbrand.com/>

Phone/Fax: 609-318-0570 | Email: [bizdev@freeworldbrand.com](mailto:bizdev@freeworldbrand.com)



Global Traders: Operators of the Unconventional Inventory Liquidation Marketplace FreeWorldImports.com

---

## **FWI UNLISTED PRODUCTS | HIGHLY DISCOUNTED**

---

*Please click on the image or the associated hyperlink to learn more*

---



## **DEPARTMENT STORES MIXED BUNDLES FOR BIG SAVINGS**

---

309 Fellowship Road | East Gate Center | Suite 200 | Mt. Laurel | NJ 08054

Web-Presence: <http://freeworldbrand.com> | Liquidation Marketplace: <https://freeworldimports.com>

Commodities Webstore: <https://commodities.freeworldbrand.com/>

Phone/Fax: 609-318-0570 | Email: [bizdev@freeworldbrand.com](mailto:bizdev@freeworldbrand.com)



Global Traders: Operators of the Unconventional Inventory Liquidation Marketplace FreeWorldImports.com

---

## **FWI UNLISTED PRODUCTS | HIGHLY DISCOUNTED**

---

*Please click on the image or the associated hyperlink to learn more*

---



**FWI FEATURED SUPPLIERS**

---

309 Fellowship Road | East Gate Center | Suite 200 | Mt. Laurel | NJ 08054

Web-Presence: <http://freeworldbrand.com> | Liquidation Marketplace: <https://freeworldimports.com>

Commodities Webstore: <https://commodities.freeworldbrand.com/>

Phone/Fax: 609-318-0570 | Email: [bizdev@freeworldbrand.com](mailto:bizdev@freeworldbrand.com)



Global Traders: Operators of the Unconventional Inventory Liquidation Marketplace FreeWorldImports.com

---

## **FWI UNLISTED PRODUCTS | HIGHLY DISCOUNTED**

---

*Please click on the image or the associated hyperlink to learn more*

---



**24 X 7 X 365 NON-AUCTION DEALS**

---

309 Fellowship Road | East Gate Center | Suite 200 | Mt. Laurel | NJ 08054

Web-Presence: <http://freeworldbrand.com> | Liquidation Marketplace: <https://freeworldimports.com>

Commodities Webstore: <https://commodities.freeworldbrand.com/>

Phone/Fax: 609-318-0570 | Email: [bizdev@freeworldbrand.com](mailto:bizdev@freeworldbrand.com)



Global Traders: Operators of the Unconventional Inventory Liquidation Marketplace FreeWorldImports.com

## **FWI UNLISTED PRODUCTS | HIGHLY DISCOUNTED**

*Please click on the image or the associated hyperlink to learn more*

### **FWI LIQUIDATION MARKETPLACE AFFILIATE PROGRAM**

Become an **ONLINE INVENTORY LIQUIDATOR** using the FWI link based model which enable you to create links to any product within the FWI Marketplace. You have the ability to share these links with potential customers via email, social media and other digital mediums. You will **earn between two to five percent (2% - 5%) commission on the sales of products** which are sold based on your efforts. These links contains identifiers that will ensure that you receive compensation when a purchase is made on a linked item containing your identifier. There are no charges associated with this groundbreaking business opportunity, your participation will not cost you a dime, it is completely free of charge.

**Online  
Inventory  
Liquidation  
Marketplace**



**Buying  
Platform**

<https://www.freeworldimports.com/>

📞 609-318-0570

✉ [bizdev@freeworldimports.com](mailto:bizdev@freeworldimports.com)



**ONLINE INVENTORY LIQUIDATOR REGISTRATION**

### **FWI AFFILIATE PROGRAM**

309 Fellowship Road | East Gate Center | Suite 200 | Mt. Laurel | NJ 08054

Web-Presence: <http://freeworldbrand.com> | Liquidation Marketplace: <https://freeworldimports.com>

Commodities Webstore: <https://commodities.freeworldbrand.com/>

Phone/Fax: 609-318-0570 | Email: [bizdev@freeworldbrand.com](mailto:bizdev@freeworldbrand.com)



Global Traders: Operators of the Unconventional Inventory Liquidation Marketplace FreeWorldImports.com

---

## **FWI UNLISTED PRODUCTS | HIGHLY DISCOUNTED**

---

*Please click on the image or the associated hyperlink to learn more*

---



FEATURE YOUR COMPANY AND YOUR PRODUCTS WITHIN THE UNCONVENTIONAL INVENTORY LIQUIDATION MARKETPLACE

[www.freeworldimports.com](http://www.freeworldimports.com)



**JOIN US**

AS A FREEWORLDIMPORTS SUPPLIER

The central graphic is a white rectangular box with a blue border. It contains the Freeworld Imports logo in the top right corner. Below the logo, there is text inviting companies to feature their products in the marketplace, followed by the website URL. In the center, two black silhouettes of business men in suits are shaking hands, with one standing on a large blue letter 'J' and the other on a large blue letter 'S'. Below this, the words "JOIN US" are written in large, bold, blue letters, and "AS A FREEWORLDIMPORTS SUPPLIER" is written in smaller, black letters at the bottom.

### **FWI SUPPLIER ENGAGEMENT**

---

309 Fellowship Road | East Gate Center | Suite 200 | Mt. Laurel | NJ 08054

Web-Presence: <http://freeworldbrand.com> | Liquidation Marketplace: <https://freeworldimports.com>

Commodities Webstore: <https://commodities.freeworldbrand.com/>

Phone/Fax: 609-318-0570 | Email: [bizdev@freeworldbrand.com](mailto:bizdev@freeworldbrand.com)



Global Traders: Operators of the Unconventional Inventory Liquidation Marketplace FreeWorldImports.com

## **FWI UNLISTED PRODUCTS | HIGHLY DISCOUNTED**

*Please click on the image or the associated hyperlink to learn more*



DELIVERING VALUE TO CALL CENTERS AND BEYOND INTEGRATED  
**VIRTUAL POINT OF SALE SOLUTION**



[www.sasapplication.com/webapplication](http://www.sasapplication.com/webapplication)

**CLOUD BASED SOLUTIONS FOR FORWARD LOOKING ORGANIZATIONS**

309 Fellowship Road | East Gate Center | Suite 200 | Mt. Laurel | NJ 08054

Web-Presence: <http://freeworldbrand.com> | Liquidation Marketplace: <https://freeworldimports.com>

Commodities Webstore: <https://commodities.freeworldbrand.com/>

Phone/Fax: 609-318-0570 | Email: [bizdev@freeworldbrand.com](mailto:bizdev@freeworldbrand.com)



Global Traders: Operators of the Unconventional Inventory Liquidation Marketplace FreeWorldImports.com

---

## **FWI UNLISTED PRODUCTS | HIGHLY DISCOUNTED**

---

*Please click on the image or the associated hyperlink to learn more*

---



### **PINK LABELED WOMEN'S URBAN APPAREL**

---

309 Fellowship Road | East Gate Center | Suite 200 | Mt. Laurel | NJ 08054

Web-Presence: <http://freeworldbrand.com> | Liquidation Marketplace: <https://freeworldimports.com>

Commodities Webstore: <https://commodities.freeworldbrand.com/>

Phone/Fax: 609-318-0570 | Email: [bizdev@freeworldbrand.com](mailto:bizdev@freeworldbrand.com)





Global Traders: Operators of the Unconventional Inventory Liquidation Marketplace FreeWorldImports.com

---

## **FWI UNLISTED PRODUCTS | HIGHLY DISCOUNTED**

---

### **FOR MORE INFORMATION FREEWORLD LIQUIDATION SERVICES**

*A Service of FreeWorld Brand, LLC*



**Phone:** +1-609-318-0570

**Email:** [bizdev@freeworldimports.com](mailto:bizdev@freeworldimports.com)

[bizdev@freeworldbrand.com](mailto:bizdev@freeworldbrand.com)

---

309 Fellowship Road | East Gate Center | Suite 200 | Mt. Laurel | NJ 08054

**Web-Presence:** <http://freeworldbrand.com> | **Liquidation Marketplace:** <https://freeworldimports.com>

Commodities Webstore: <https://commodities.freeworldbrand.com/>

**Phone/Fax:** 609-318-0570 | **Email:** [bizdev@freeworldbrand.com](mailto:bizdev@freeworldbrand.com)